

✓ (30, 150, 132)

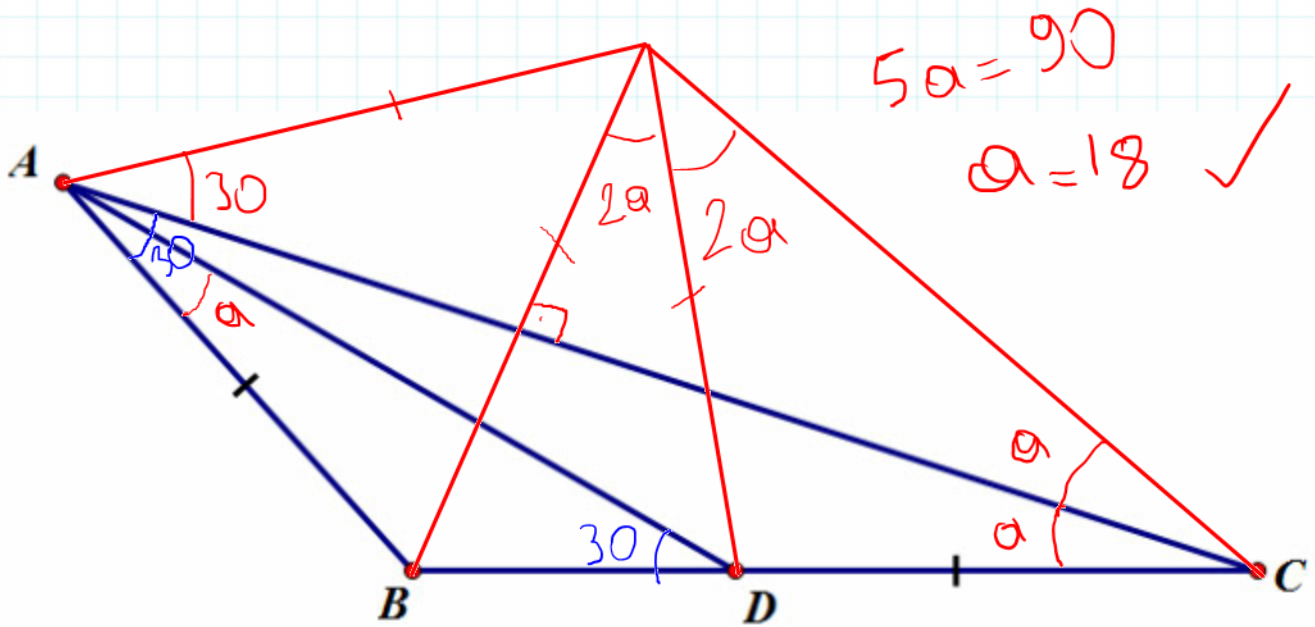

(30, 150, 132)

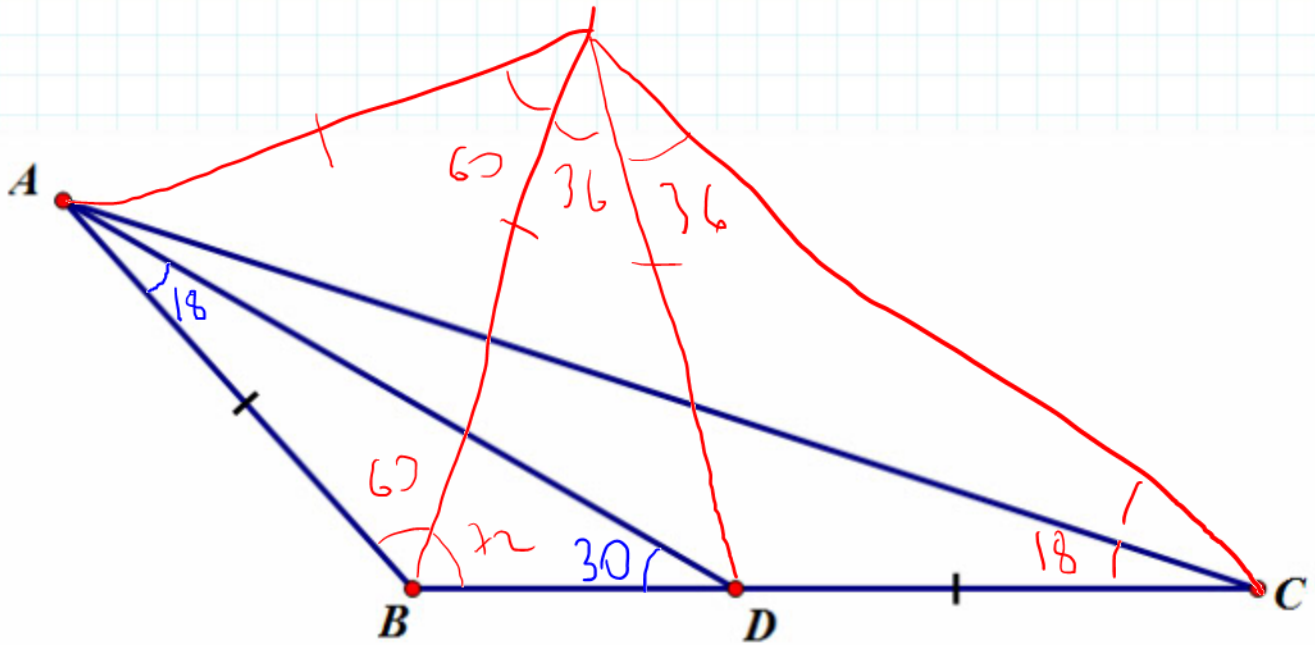
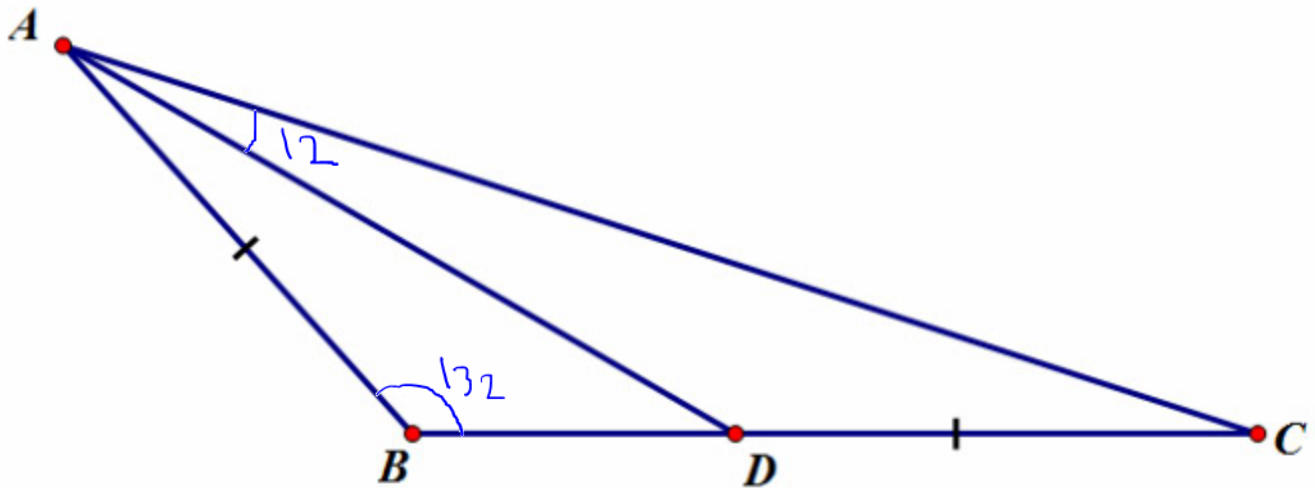

$(30, 150, 132)$  $(\text{Trigo})$ 

✓ (30, 150, 132)

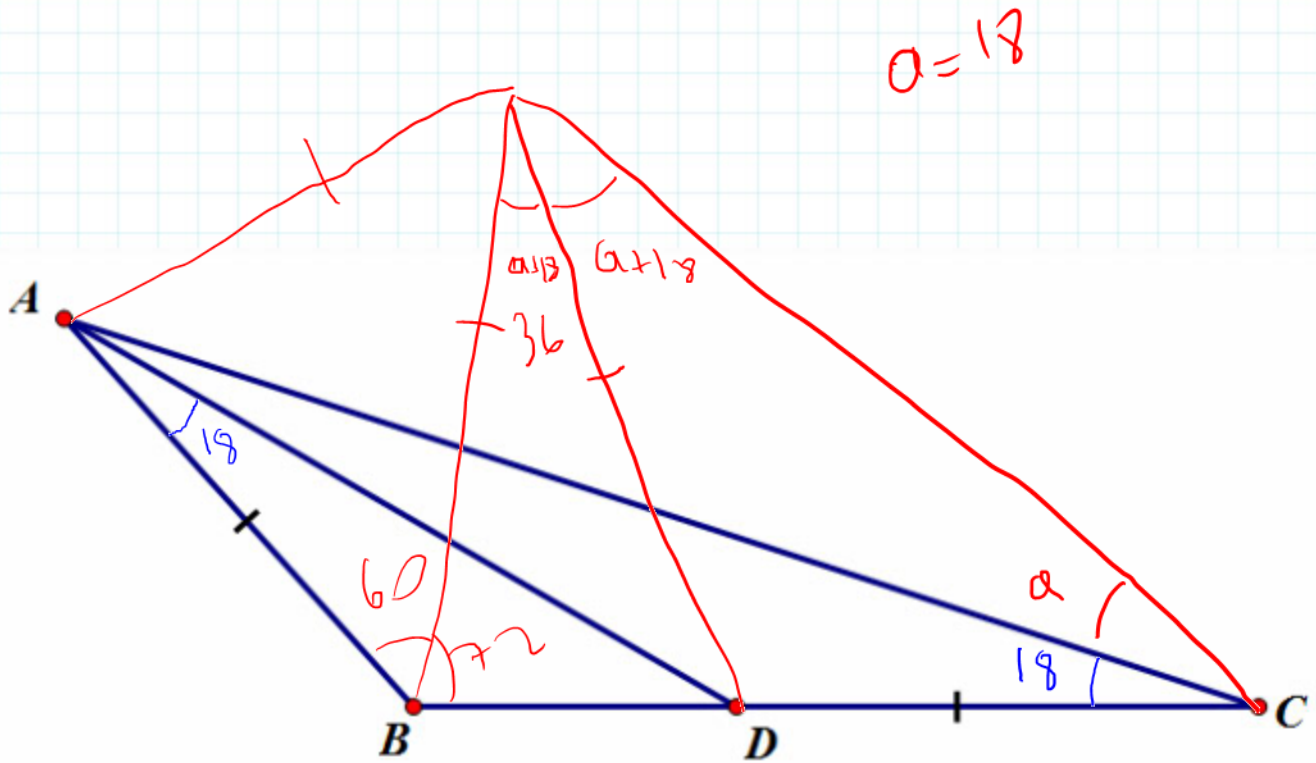

$(30, 150, 132)$

$(150, 30, 12)$   
 $= (138, 18, 12)$

Bekle  
 Buradan

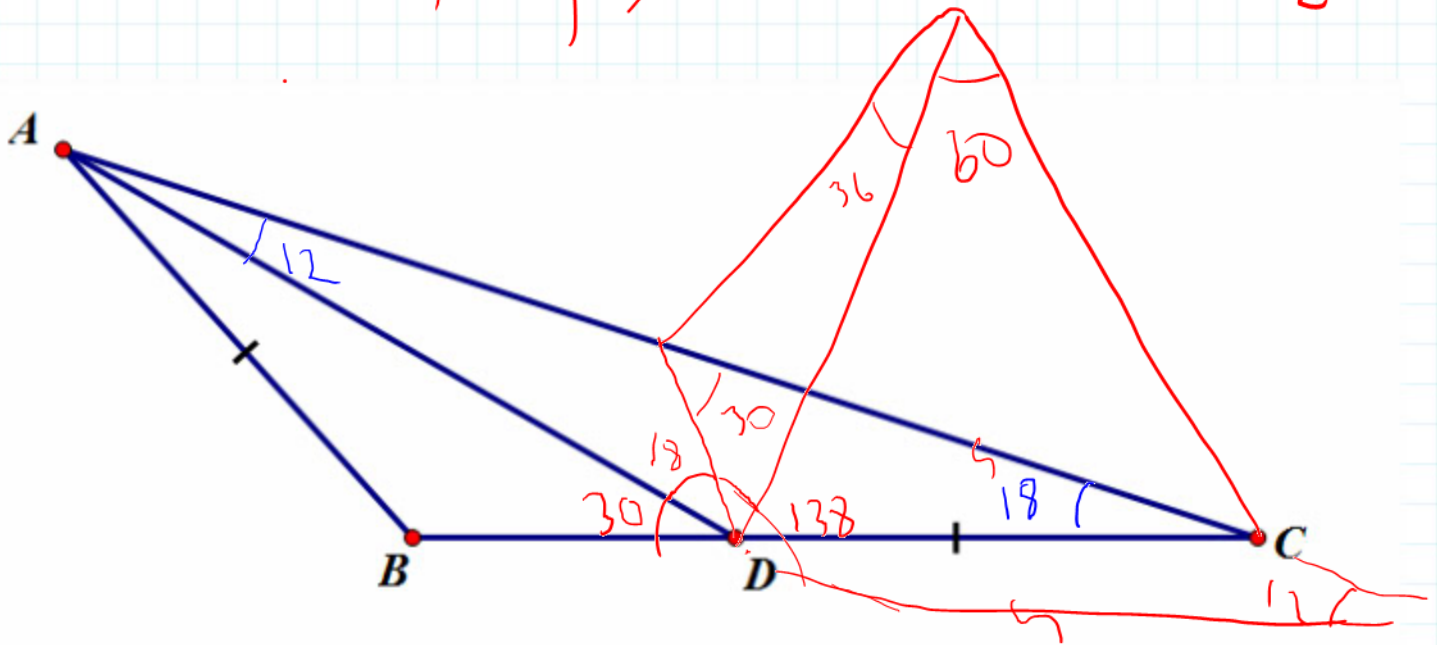

(54, 126, 96)

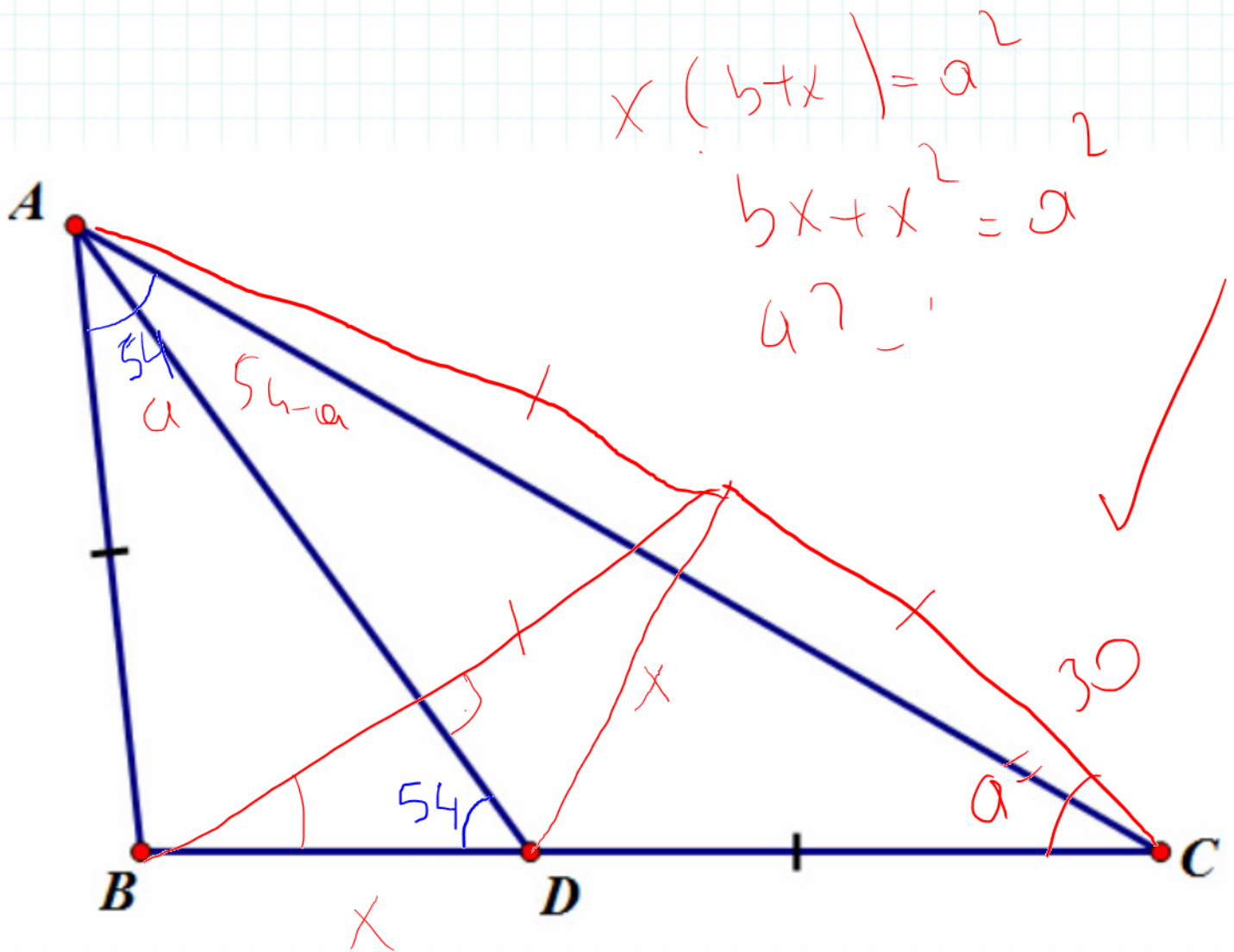

(54, 126, 96)

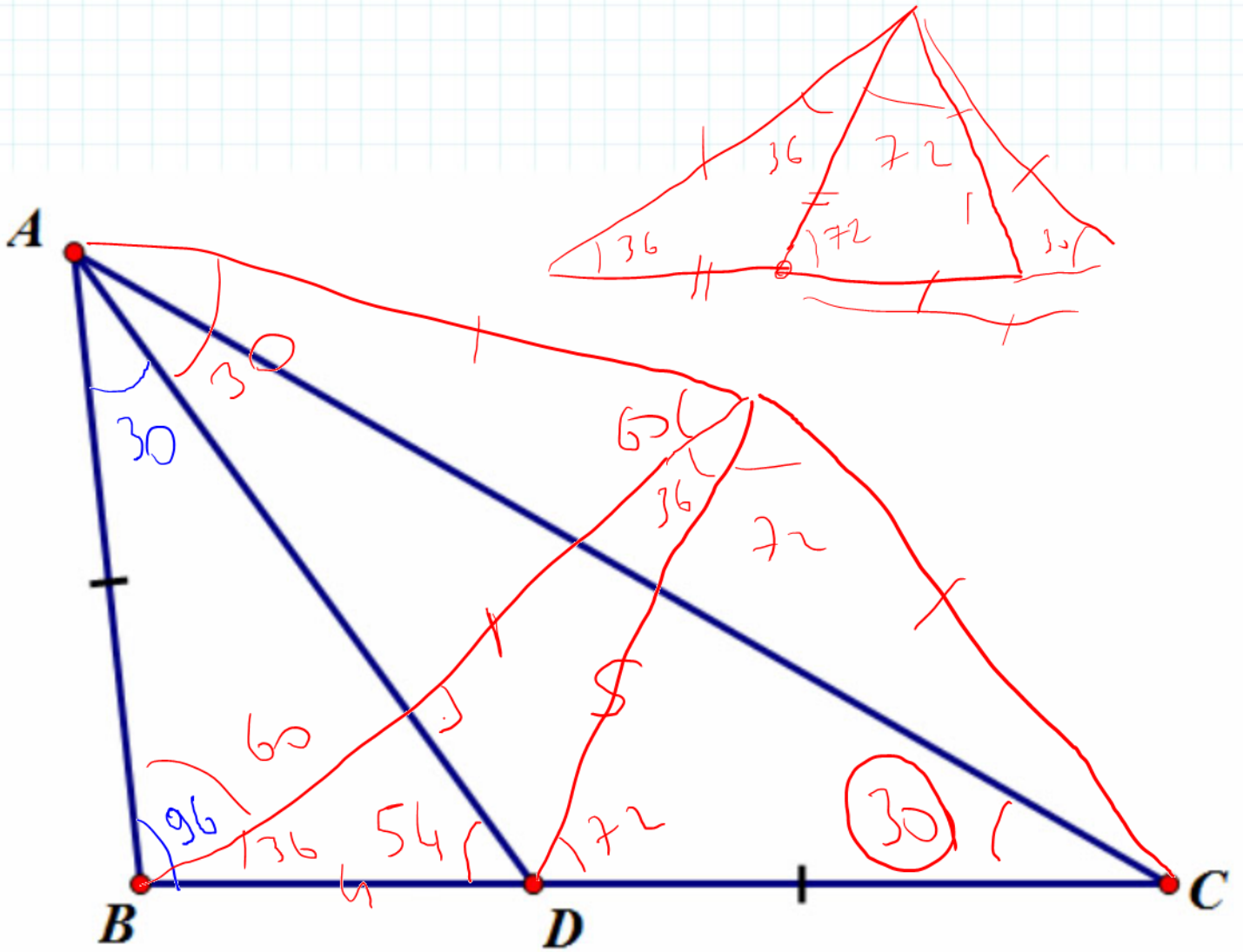

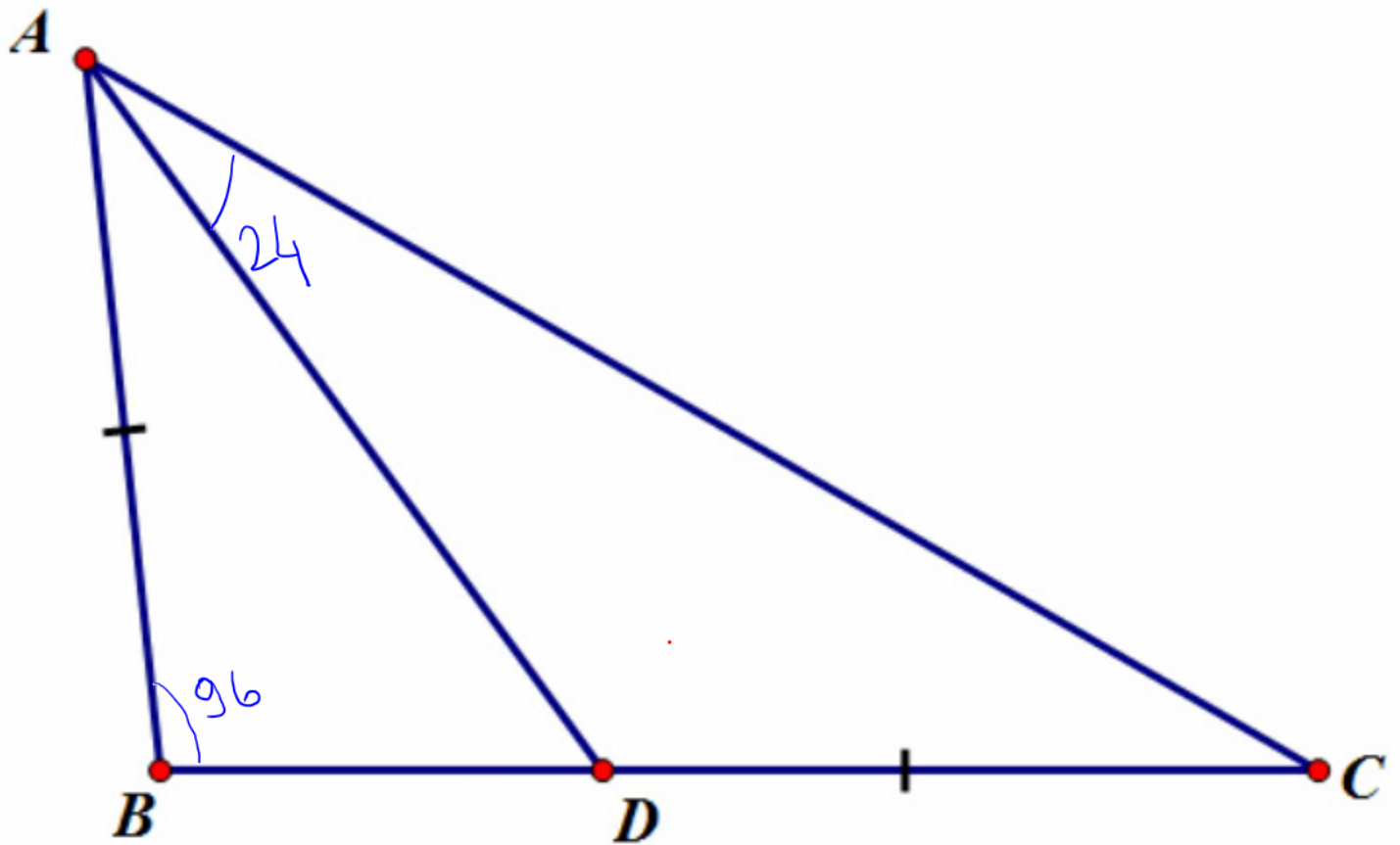
$(54, 126, 96)$ 

(54, 126, 96)

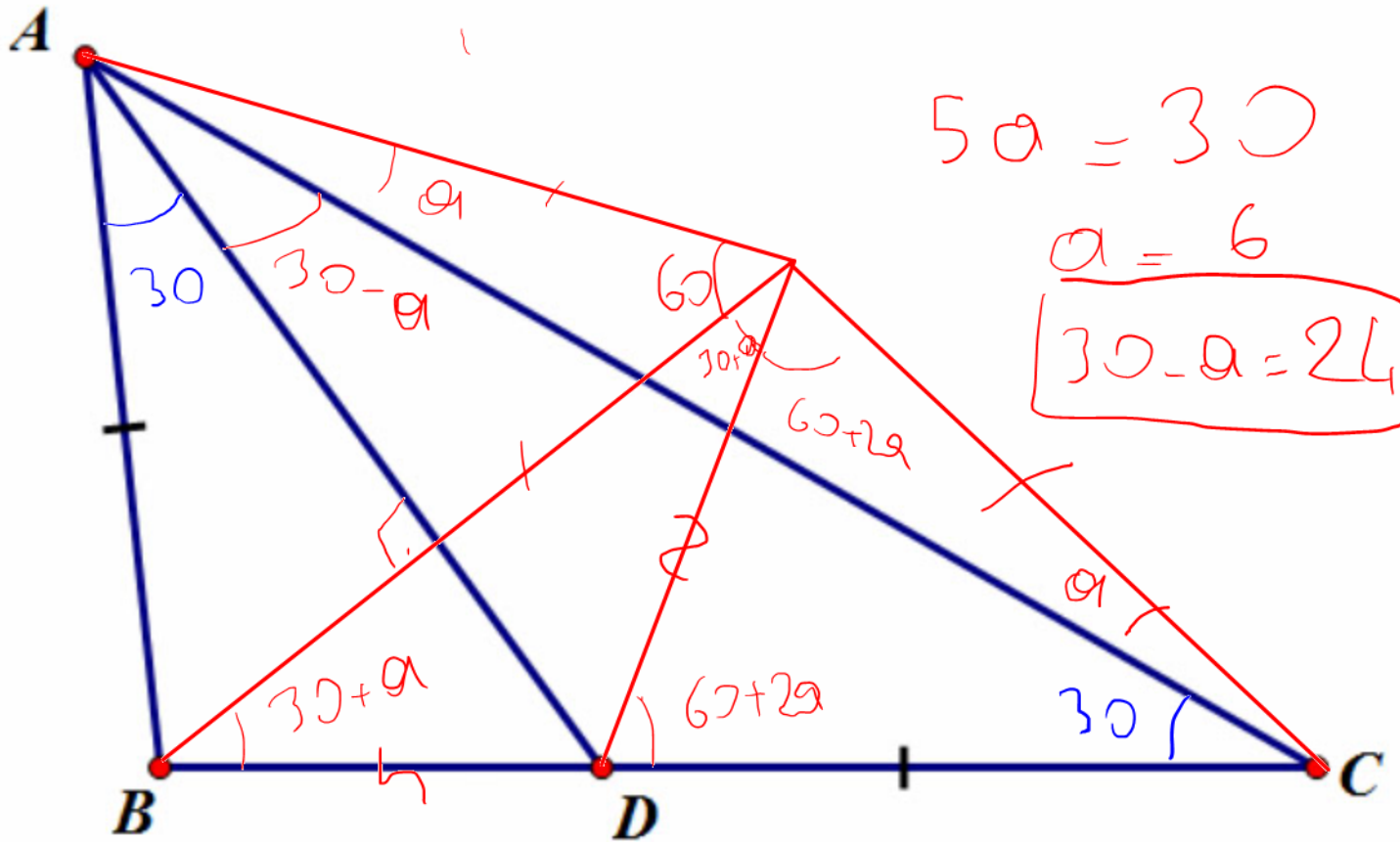

$$5a = 30$$

$$a = 6$$

$$30 - a = 24$$

$$(54, 126, 96)$$

$$(126, 54, 24)$$

$$= (102, 30, 24)$$

Bekle!

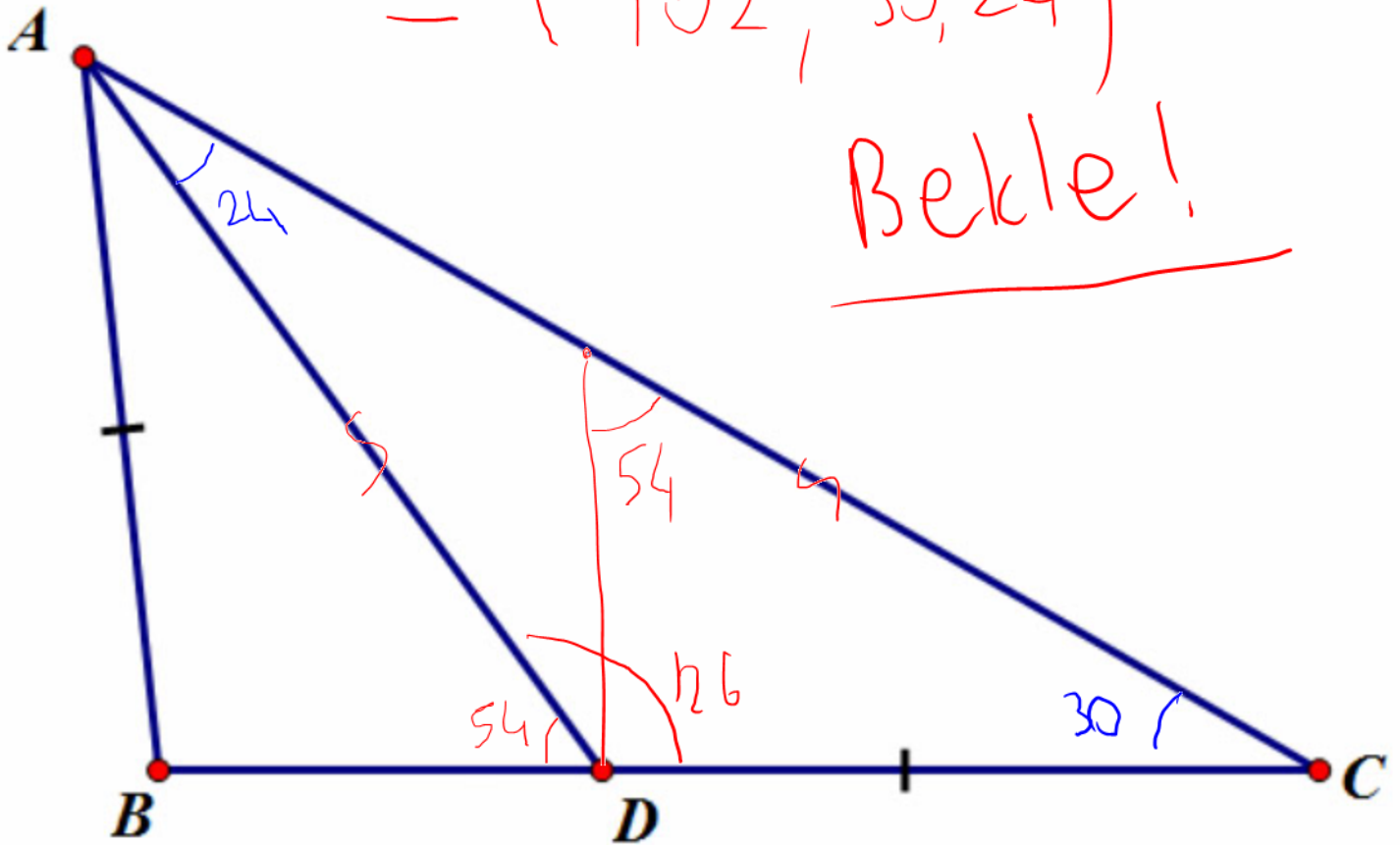

$(60, 150, 100)$

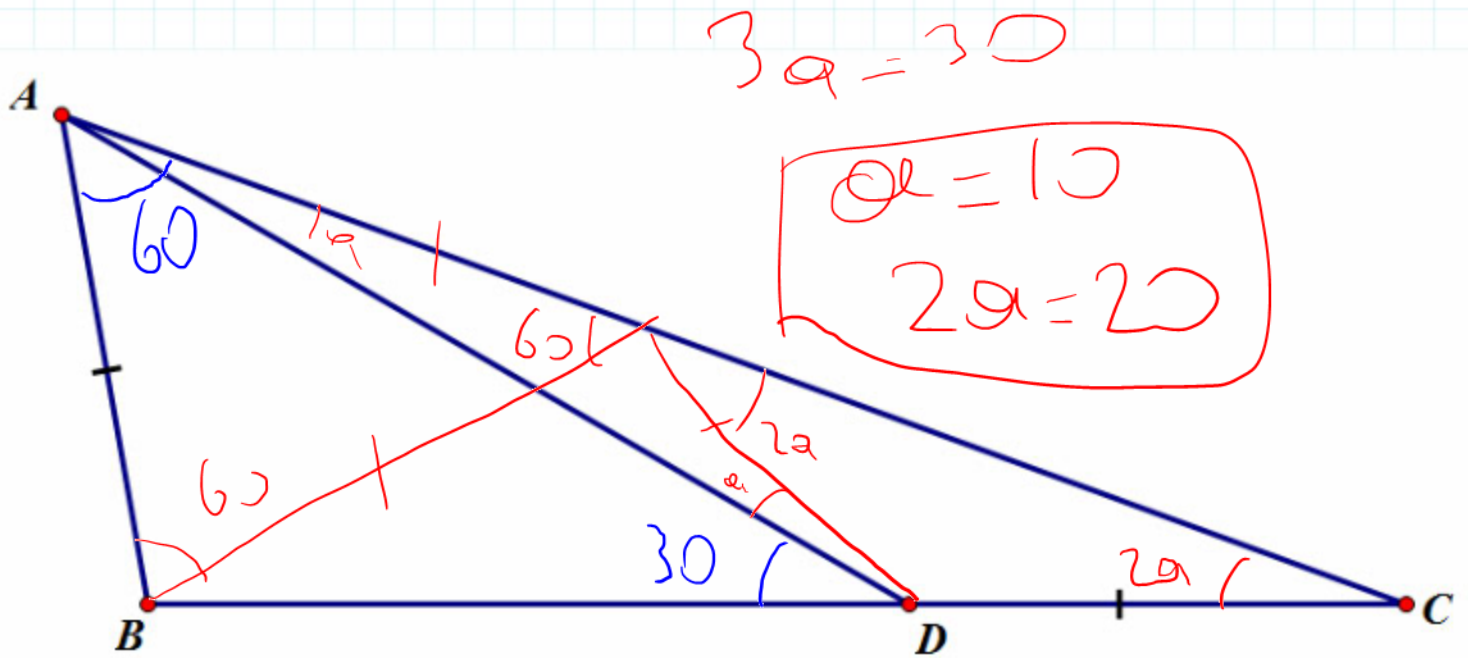

(60, 150, 100)

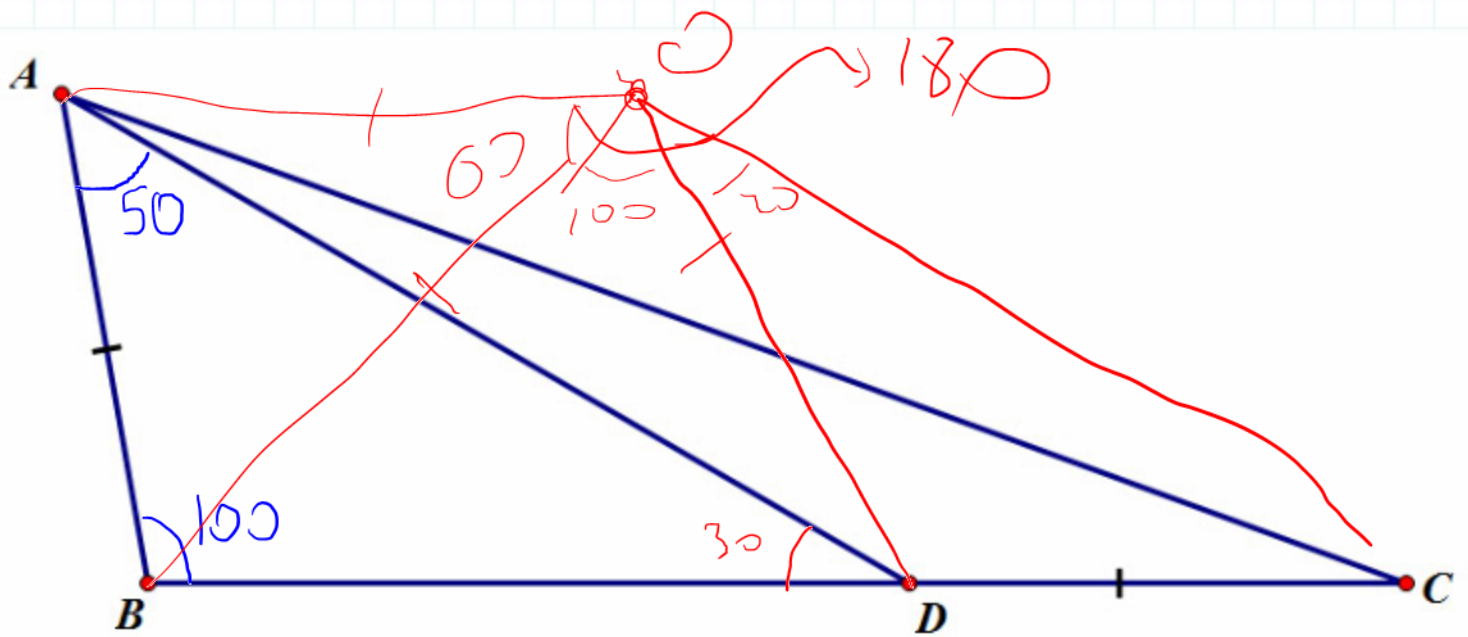

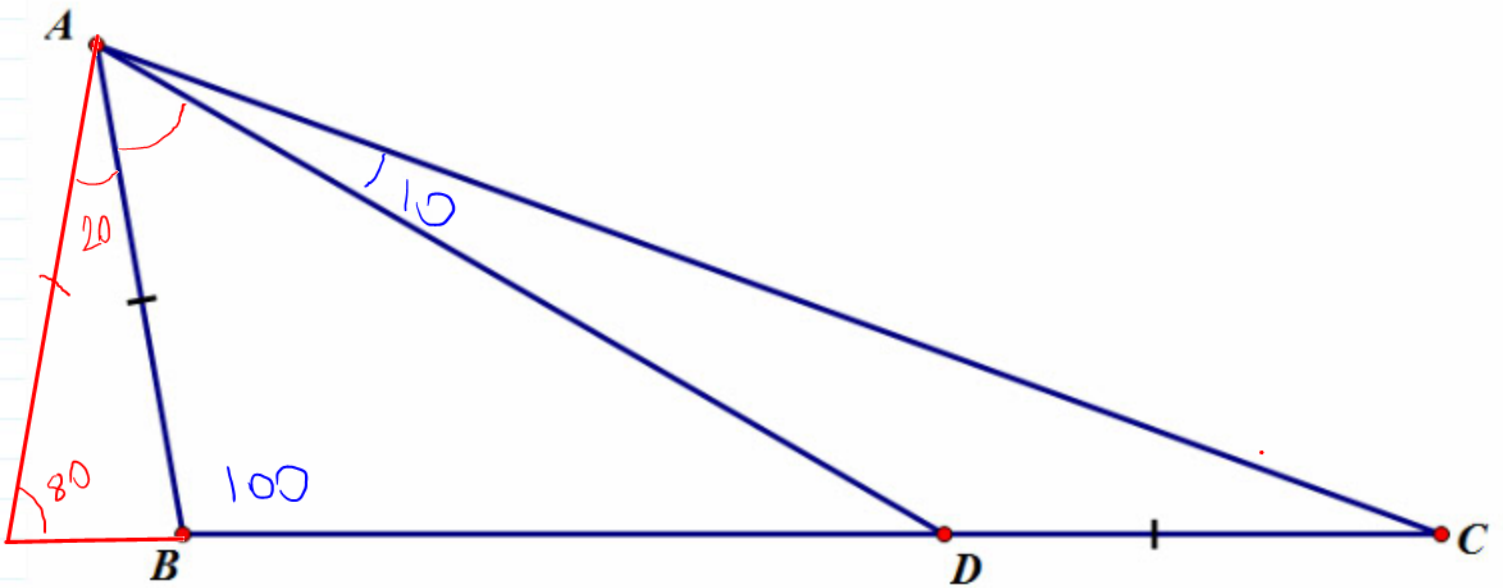
$(60, 150, 100)$ 

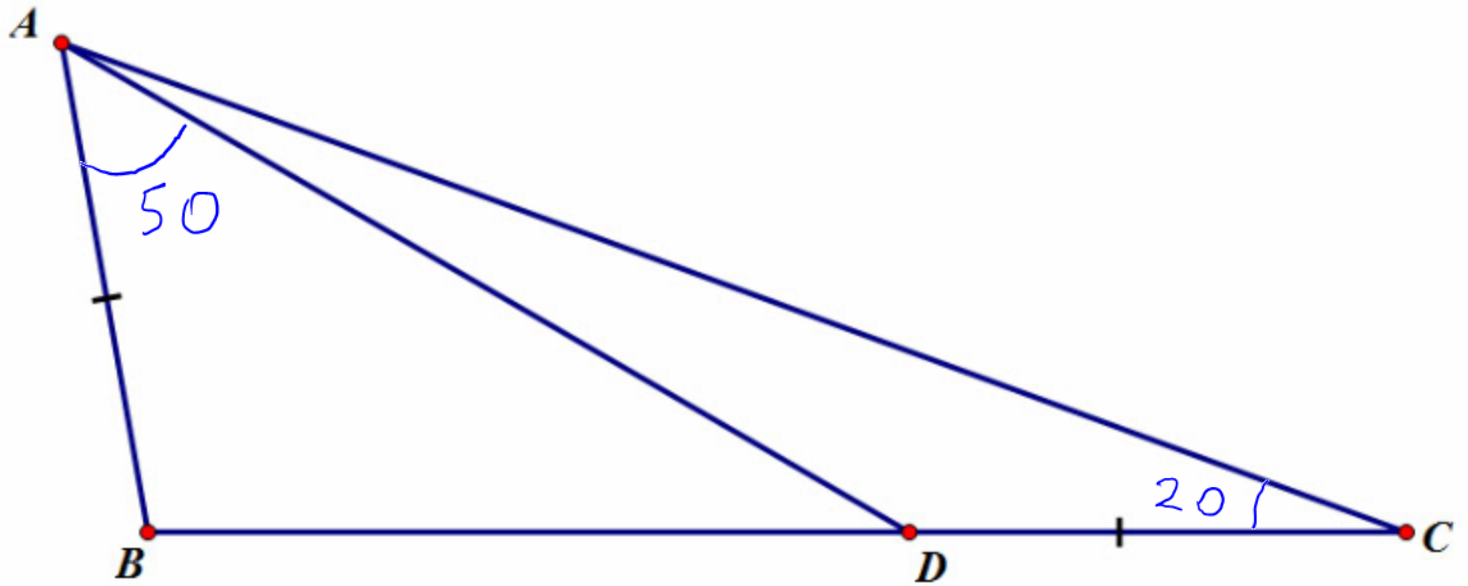
$(60, 150, 100)$ 

(60, 150, 100)

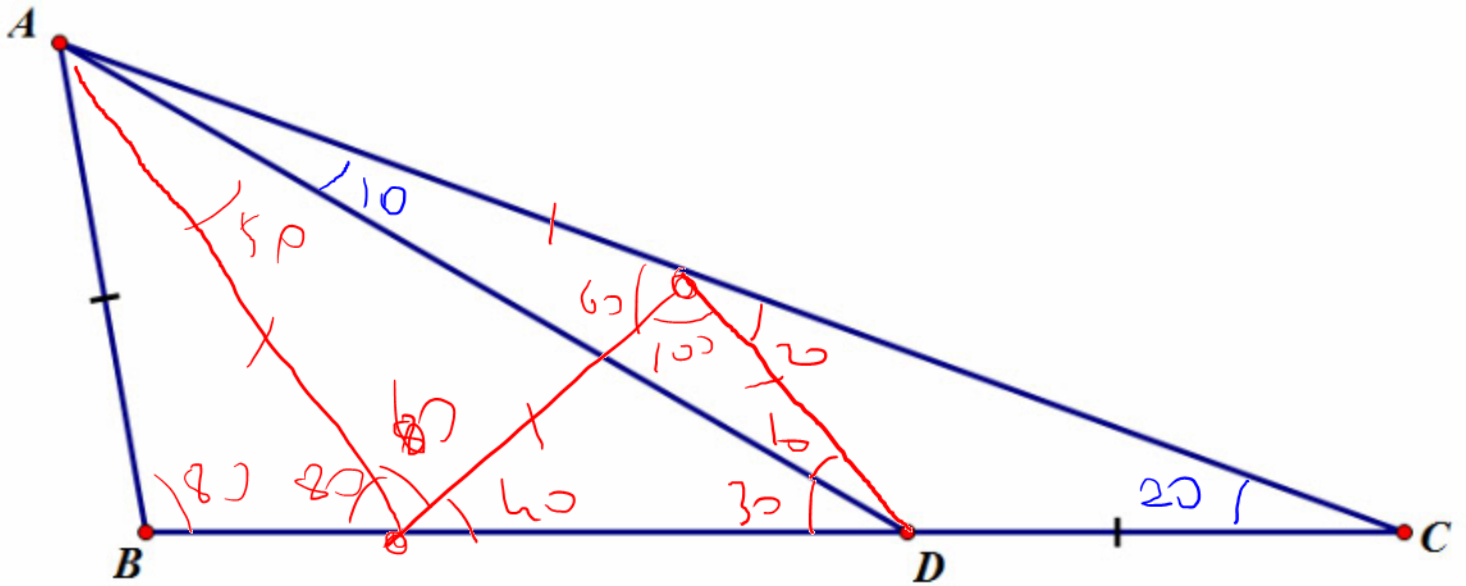

(102, 30, 24)

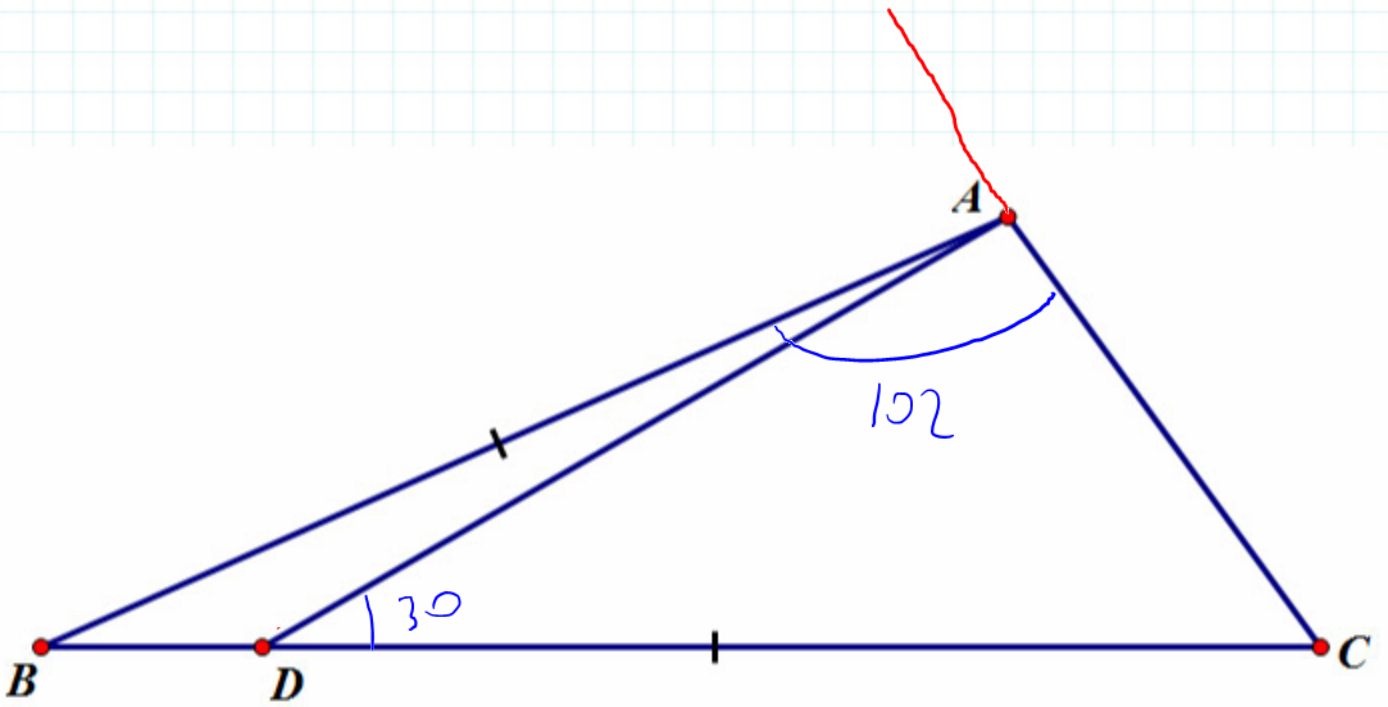

(102, 30, 24)

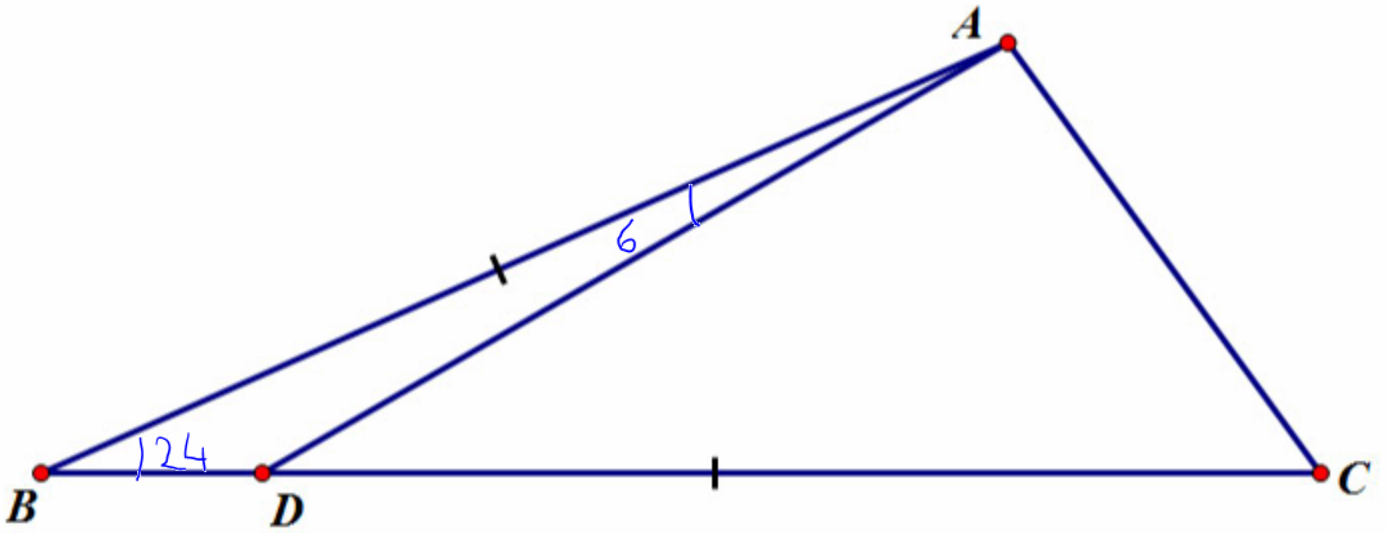

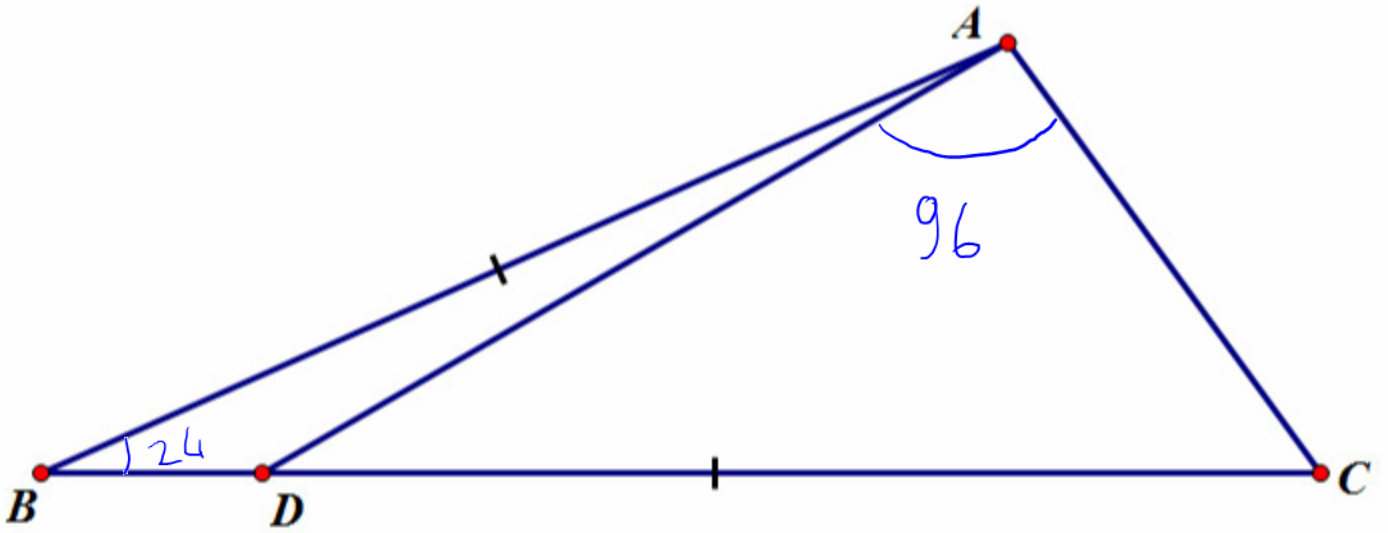
$(102, 30, 24)$ 

(102, 30, 24)

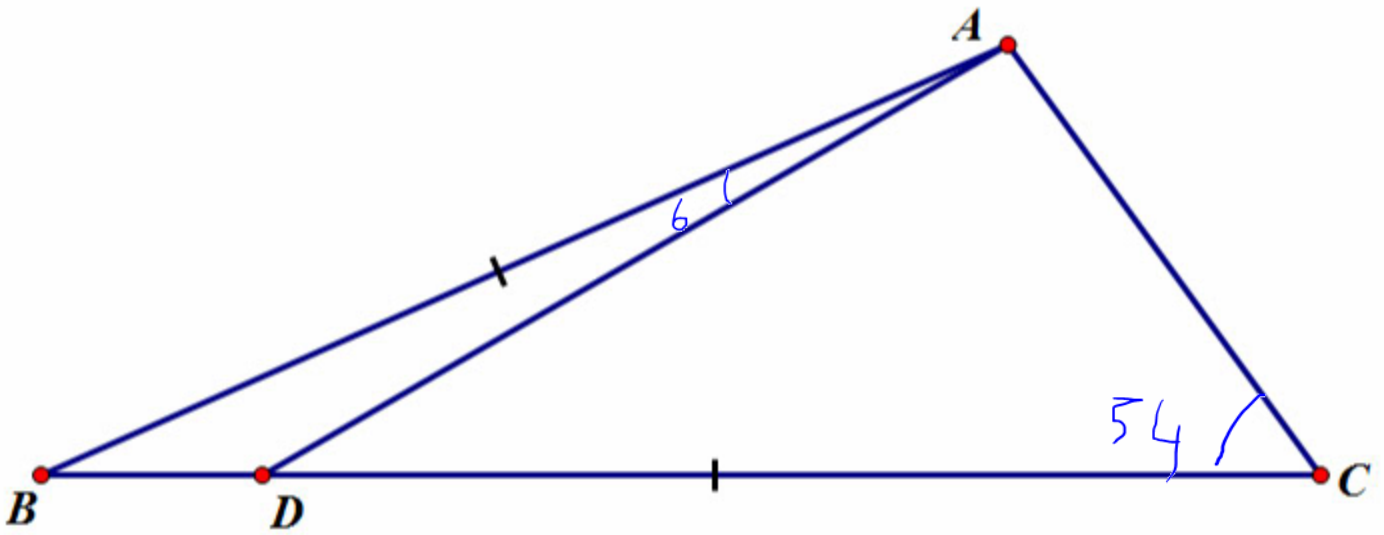

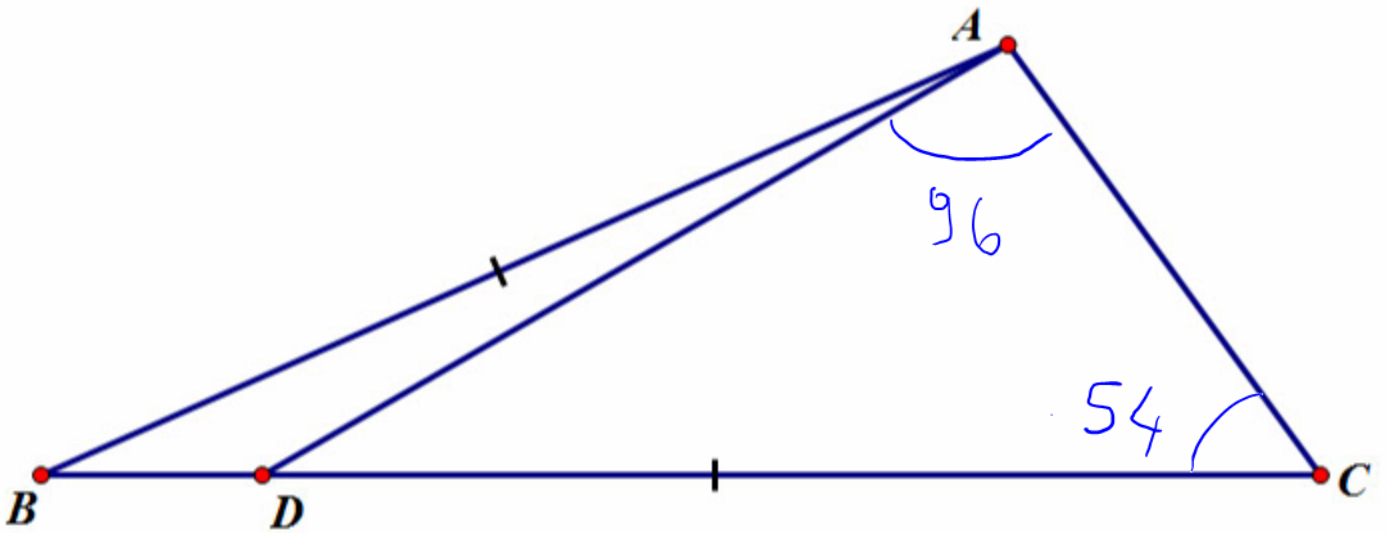
$(102, 30, 24)$ 

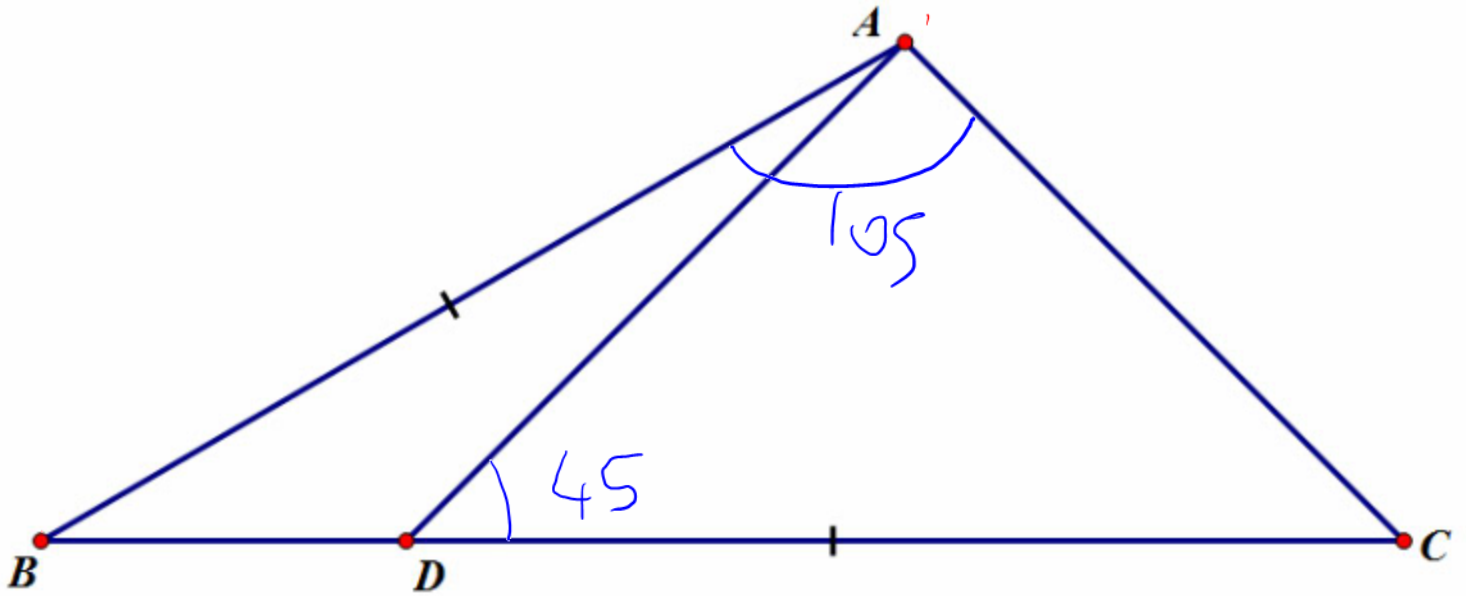
$(105, 45, 30)$ 

(105, 45, 30)

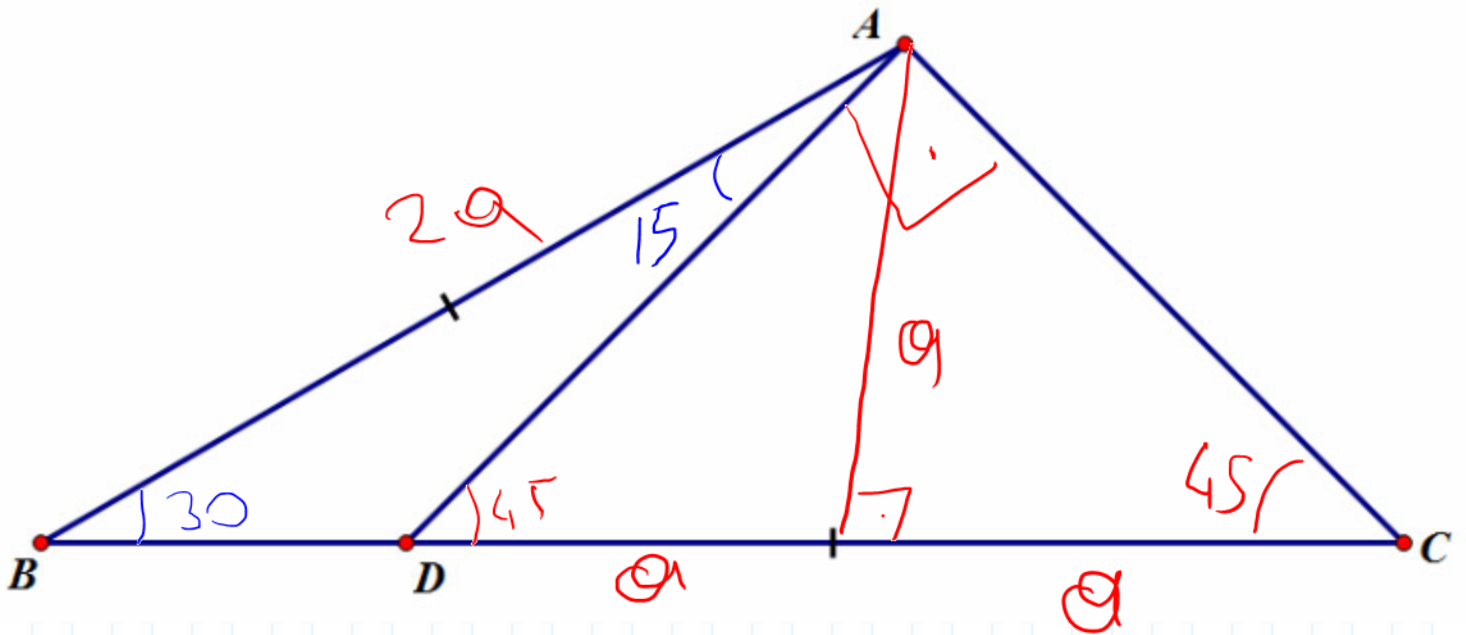

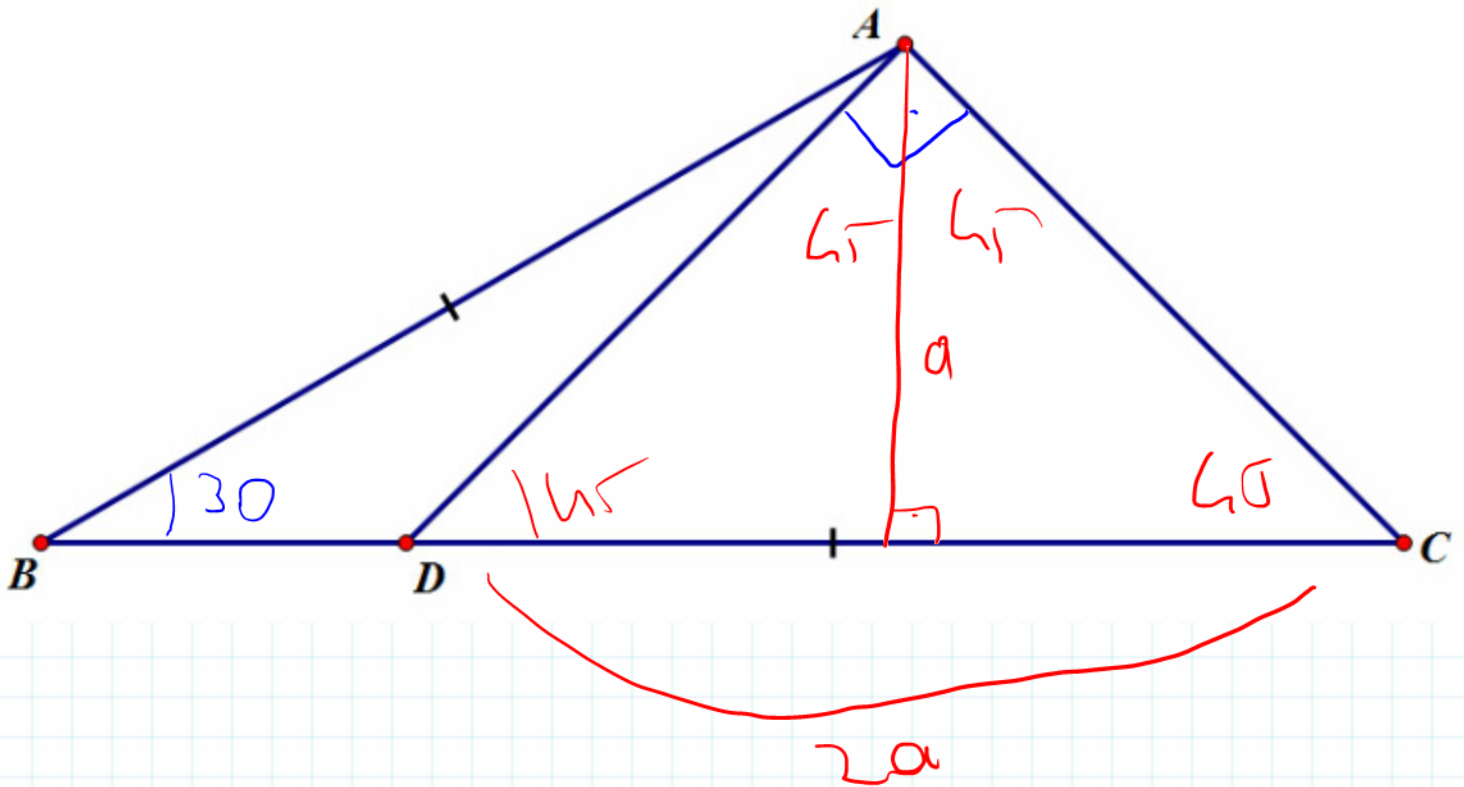
$$(105, 45, 30)$$

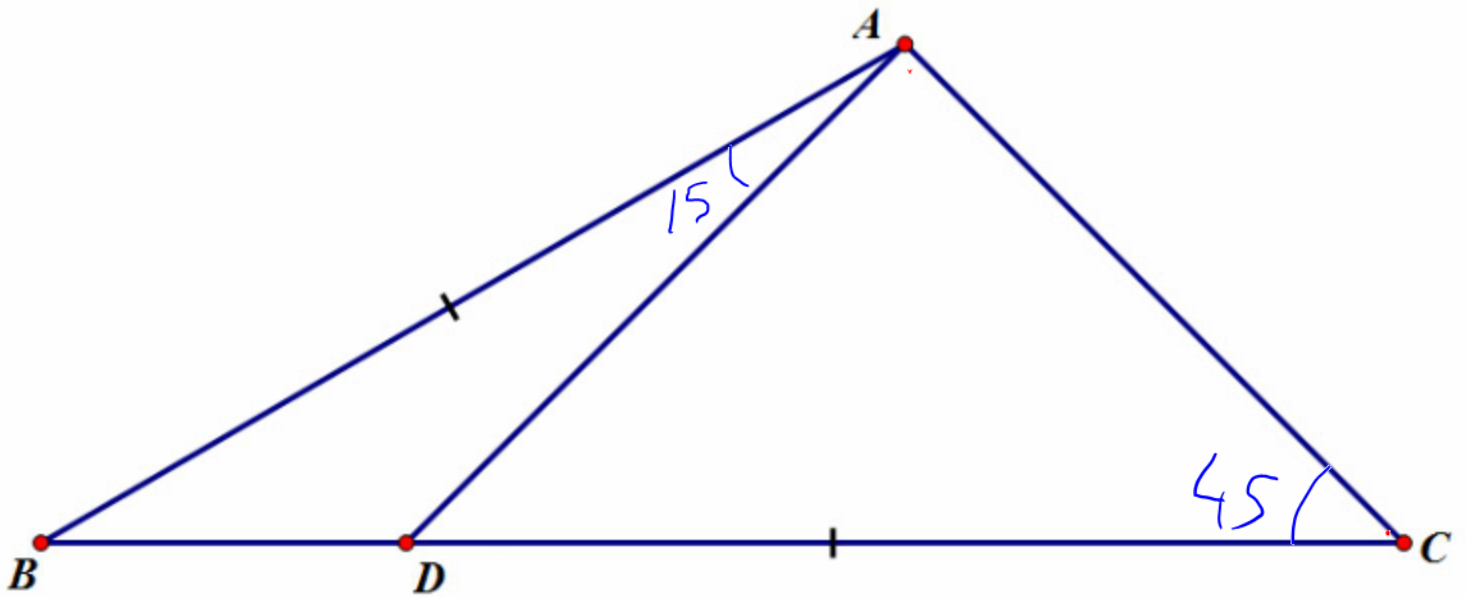
$(105, 45, 30)$ 

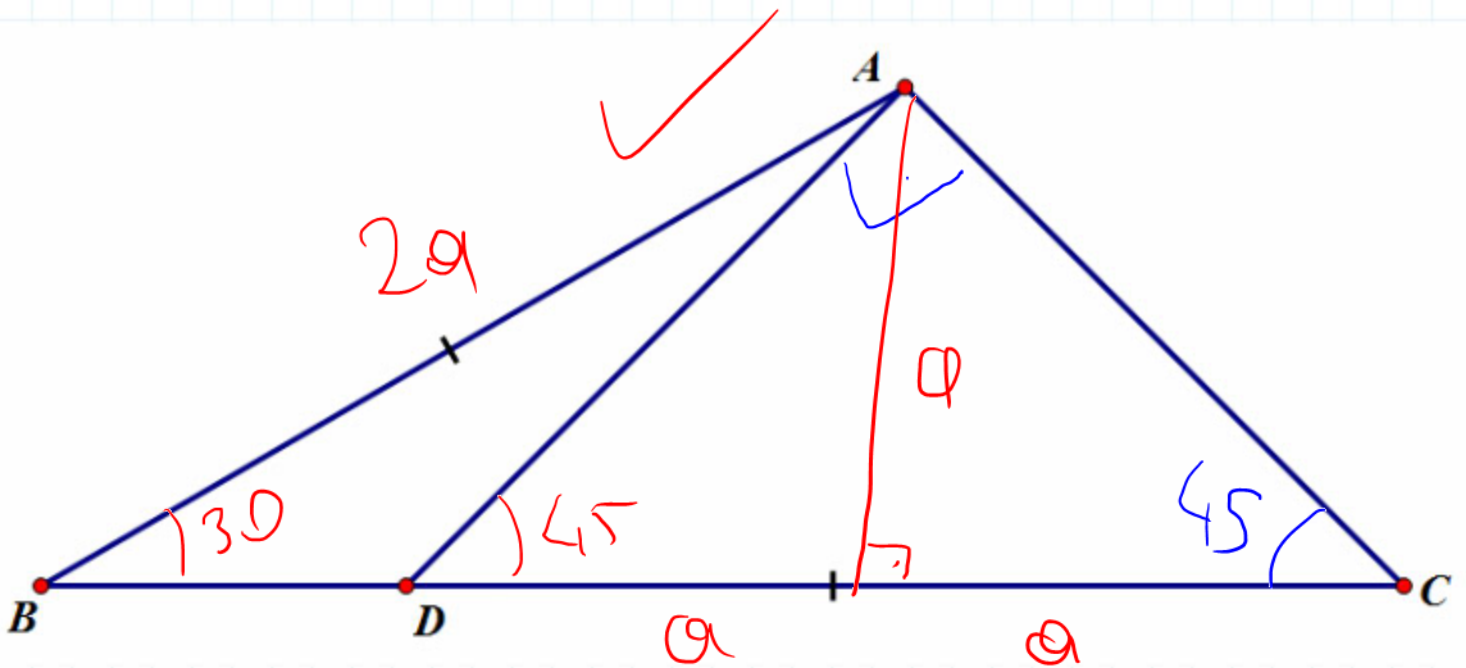
$$(105, 45, 30)$$

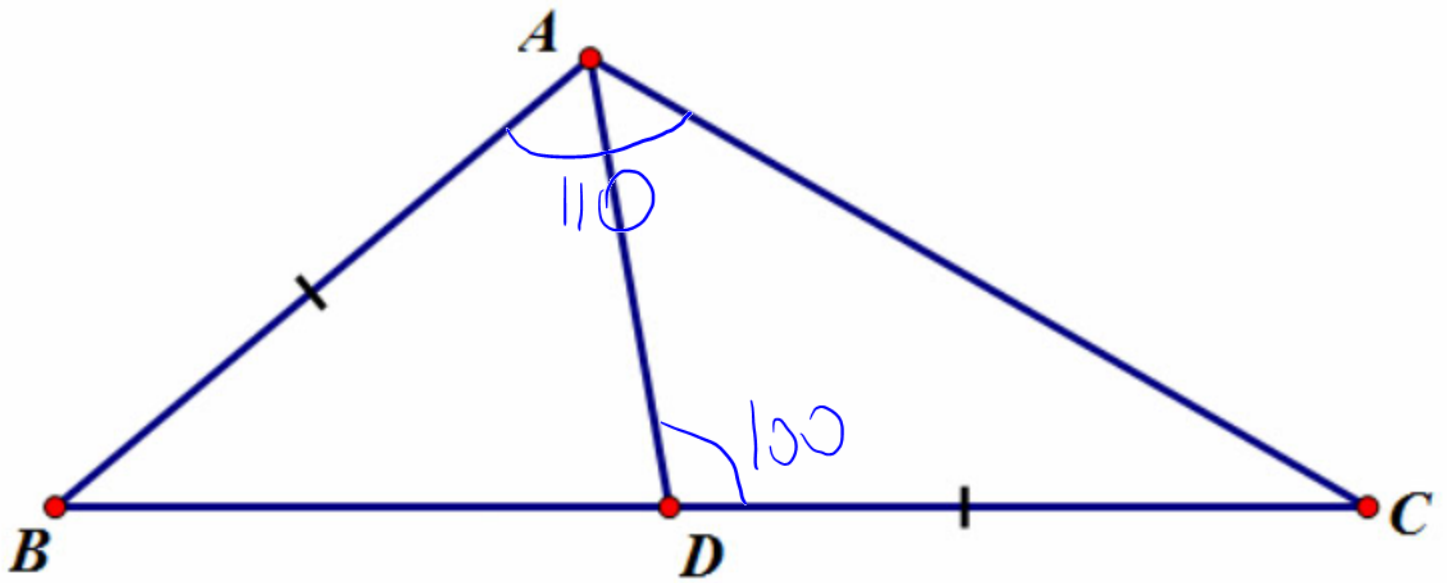
$(110, 100, 40)$ 

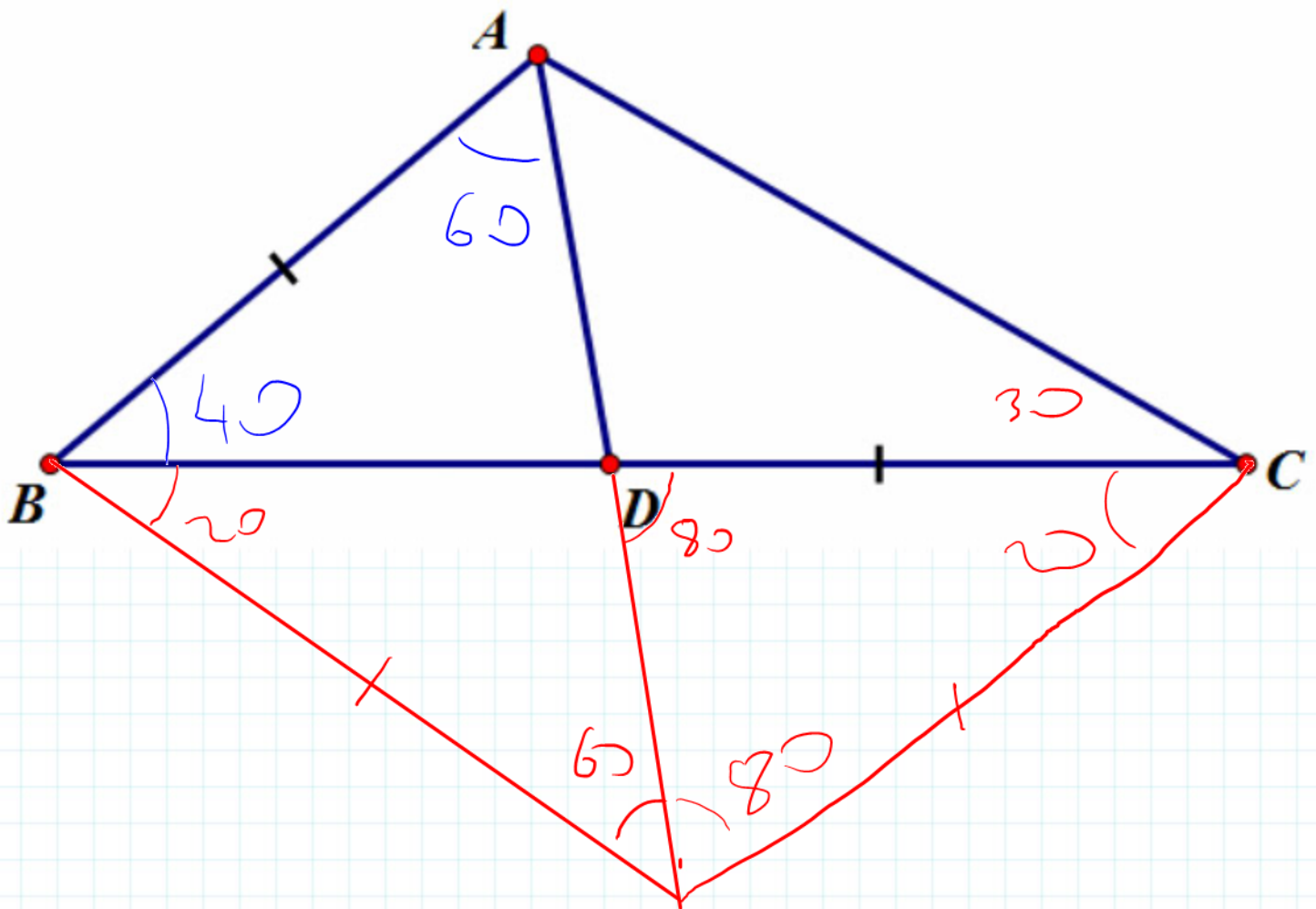
$$(110, 100, 40)$$

(110, 100, 40)

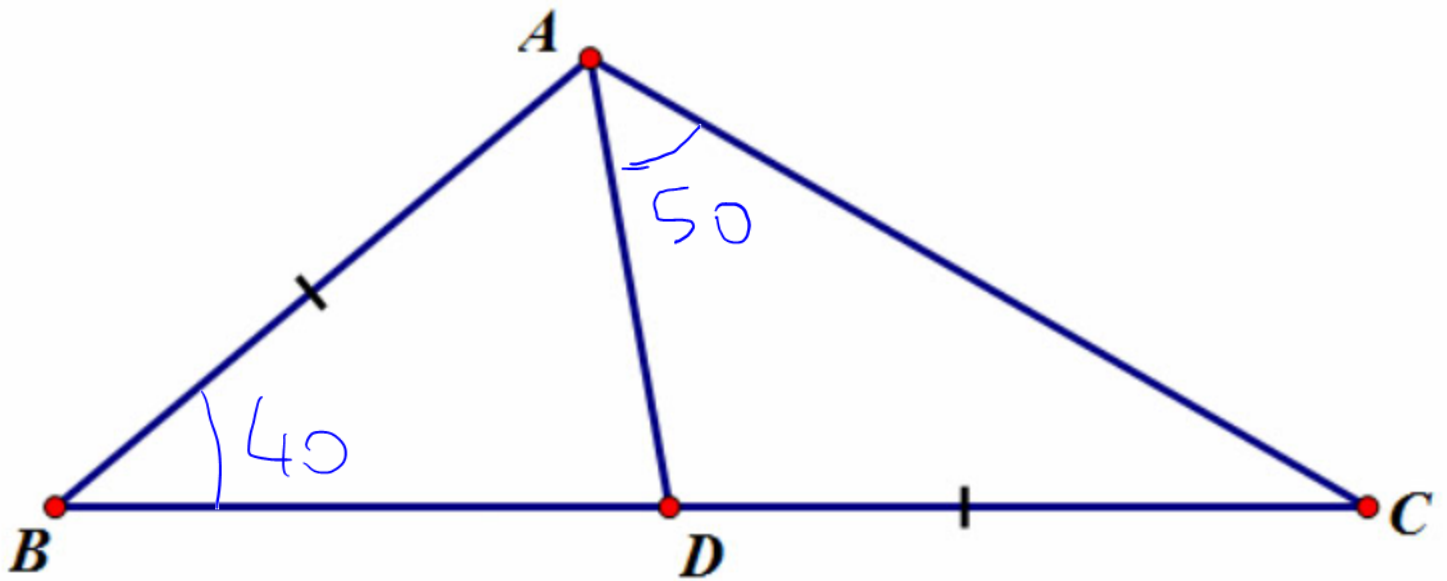

(110, 100, 40)

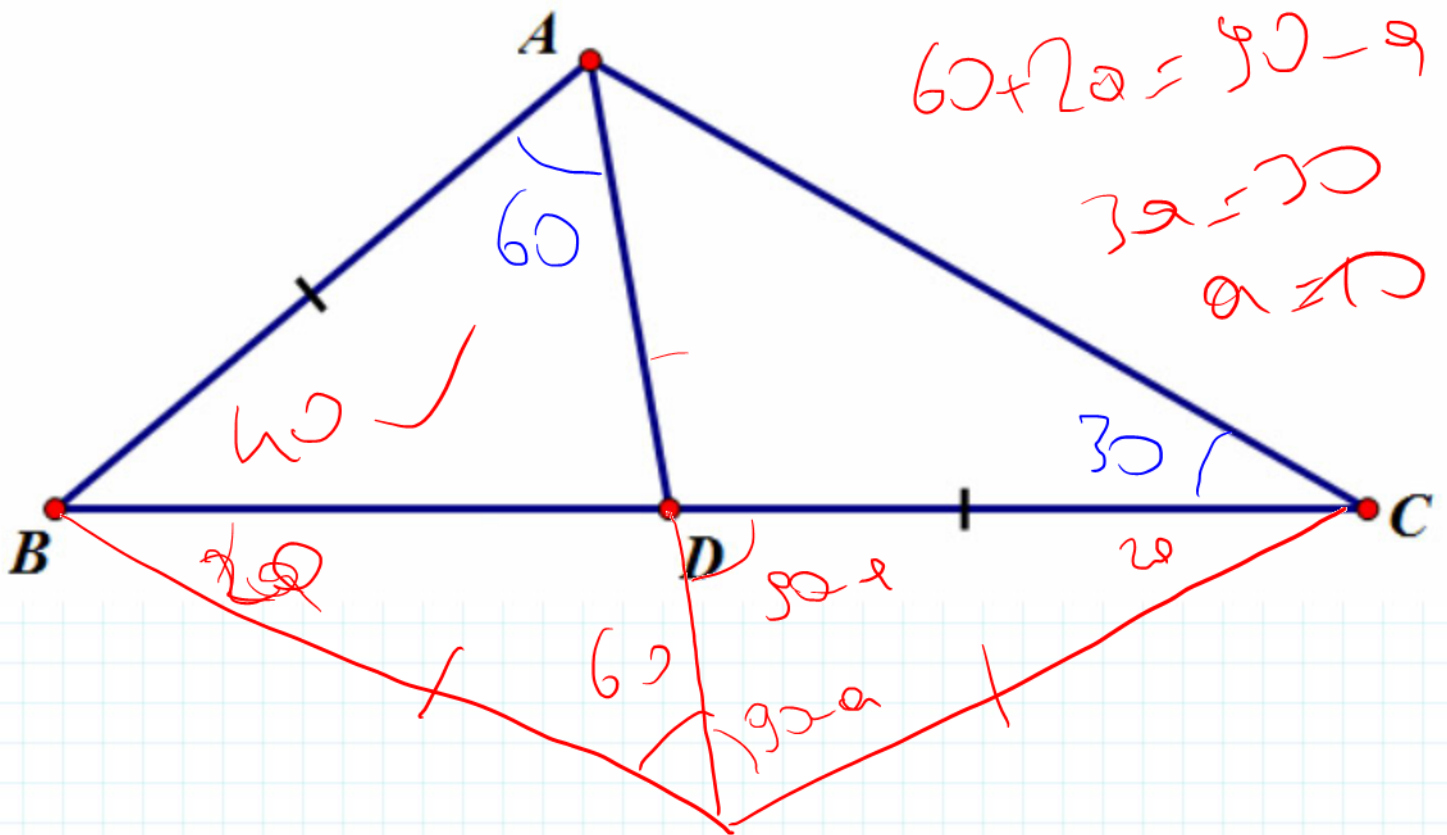

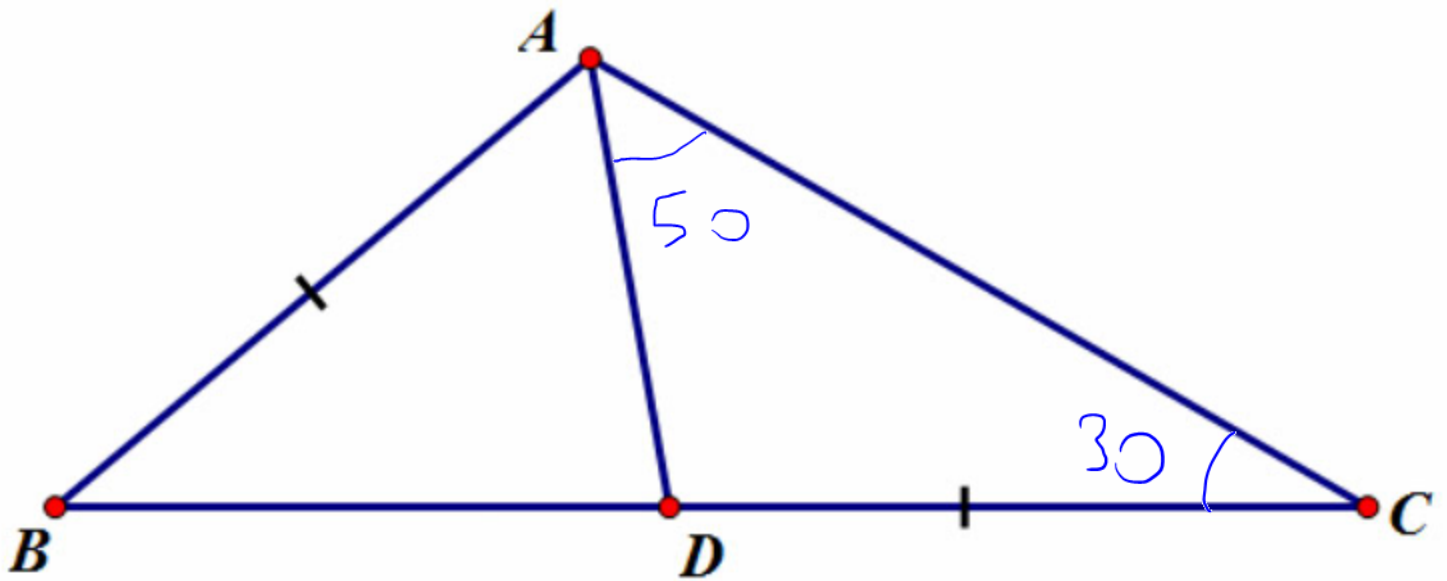
$(110, 100, 40)$ 

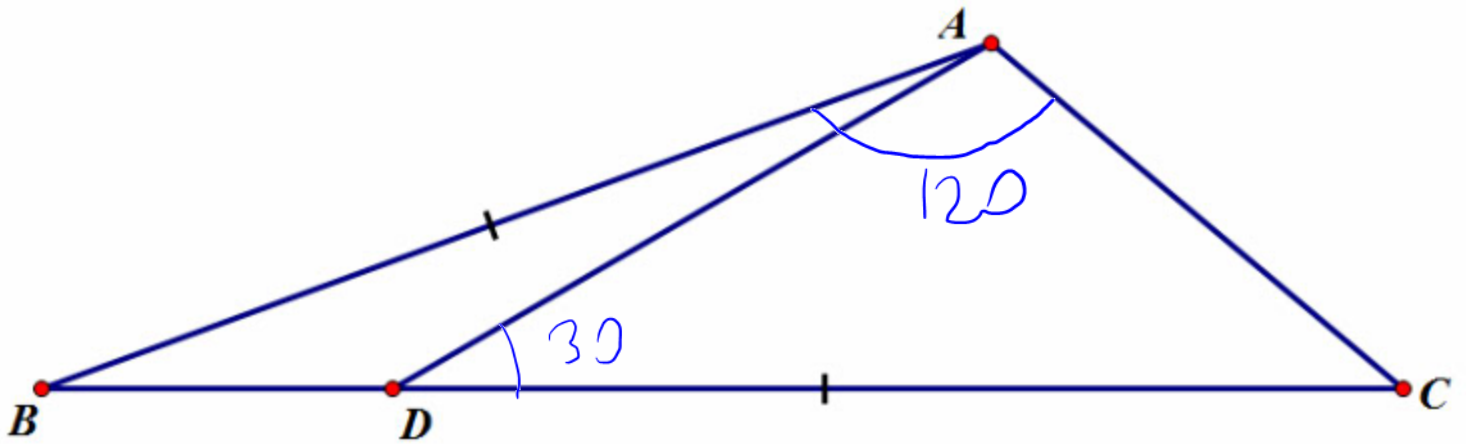
$(120, 30, 20)$ 

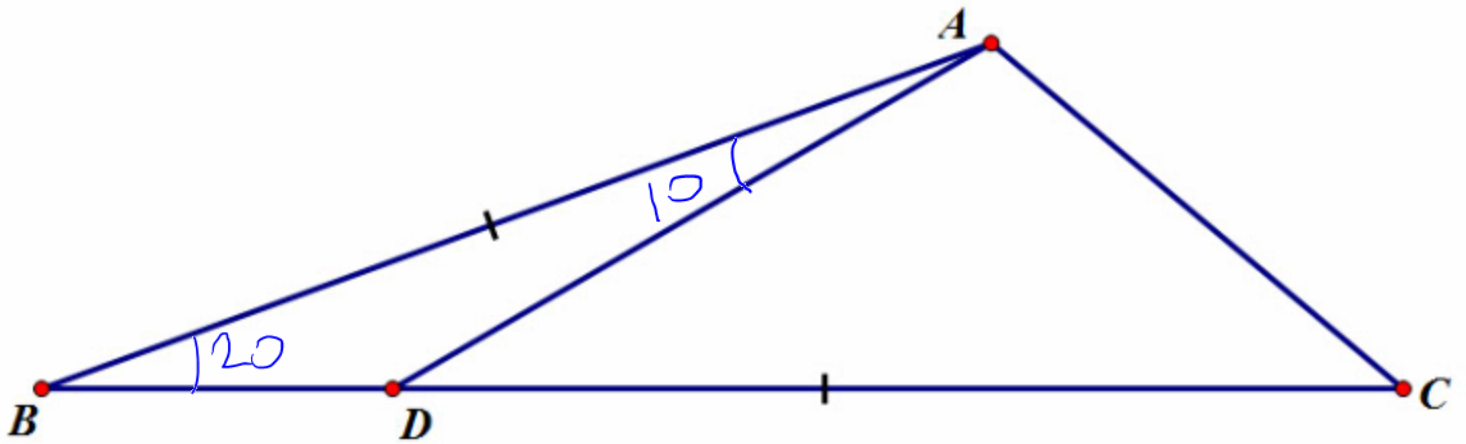
$(120, 30, 20)$ 

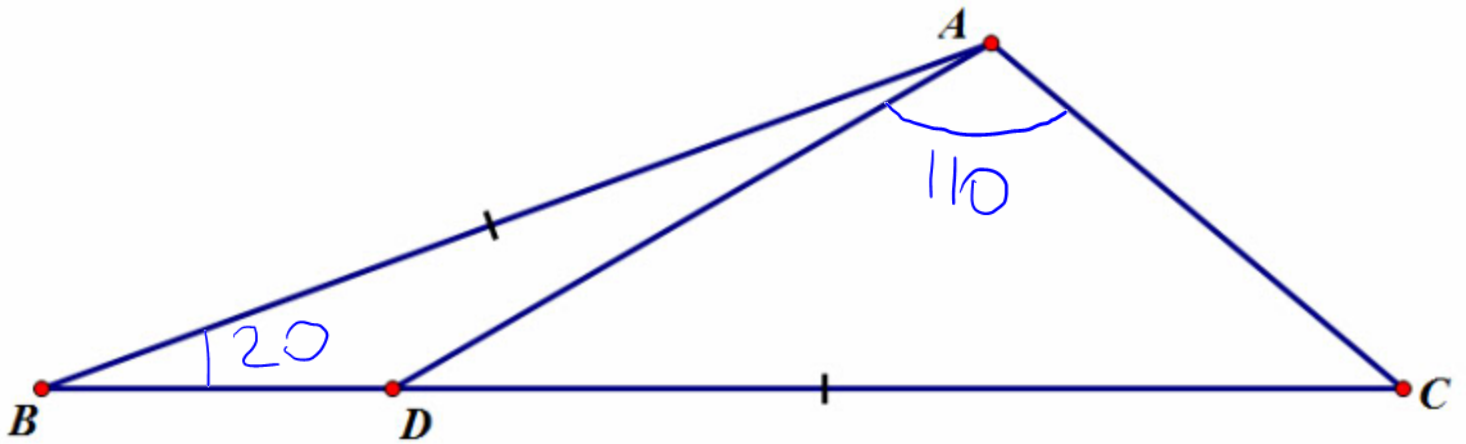
$(120, 30, 20)$ 

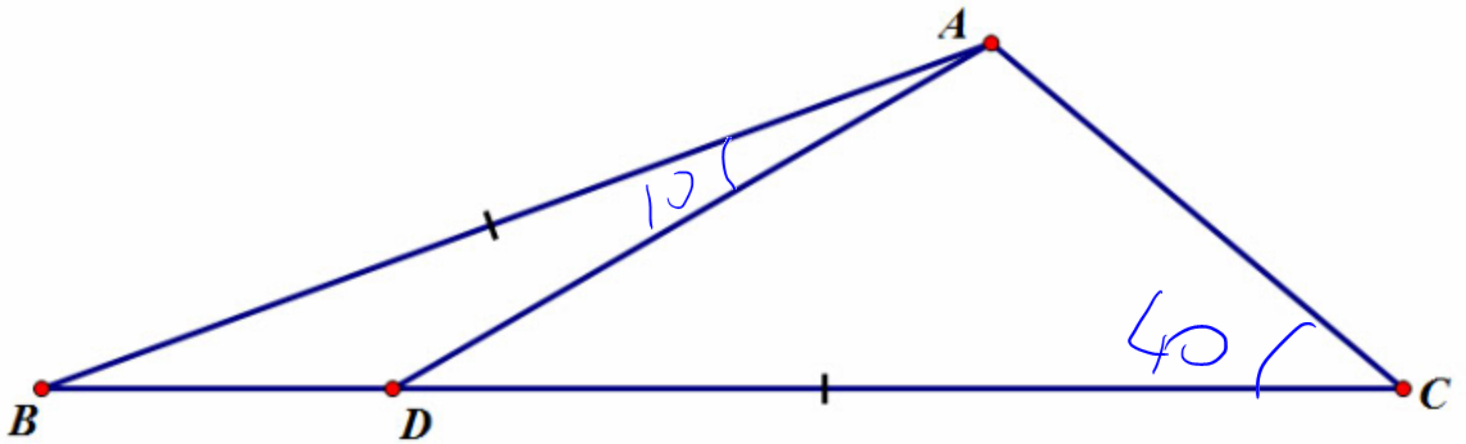
$(120, 30, 20)$ 

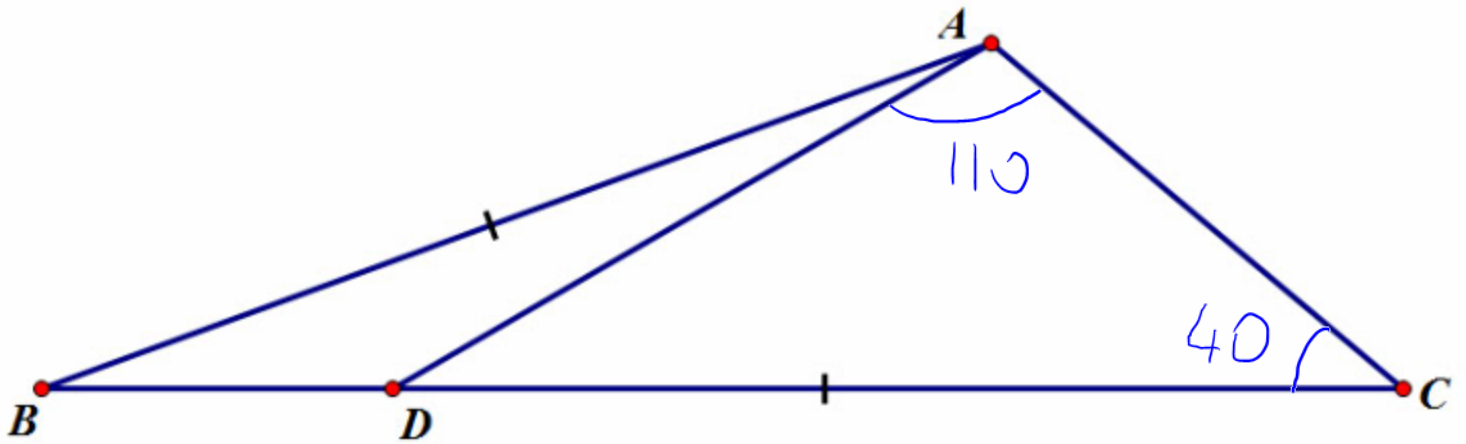
$(120, 30, 20)$ 

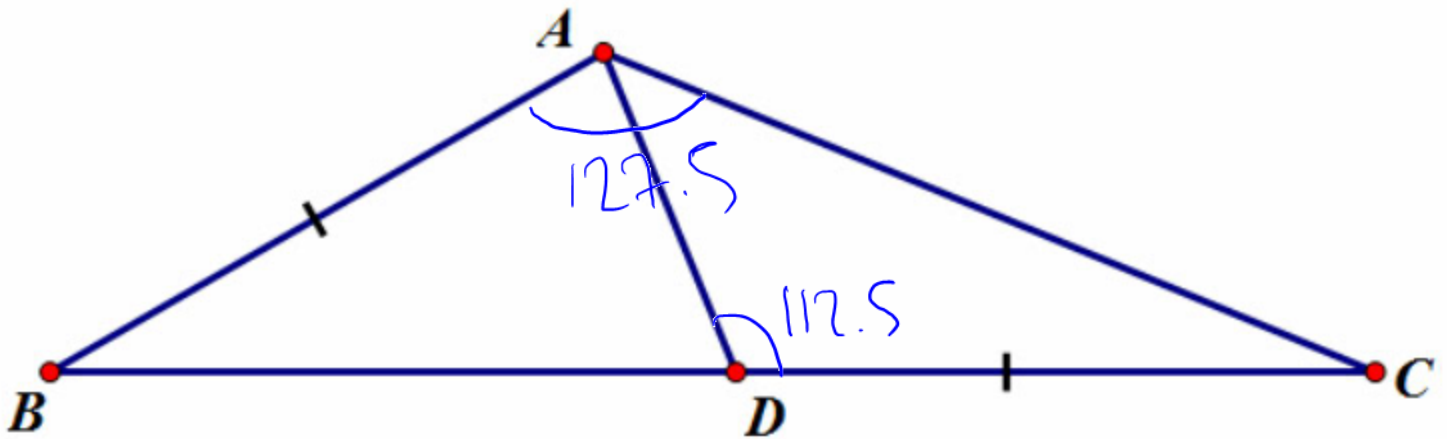
$(127.5, 112.5, 30)$ 

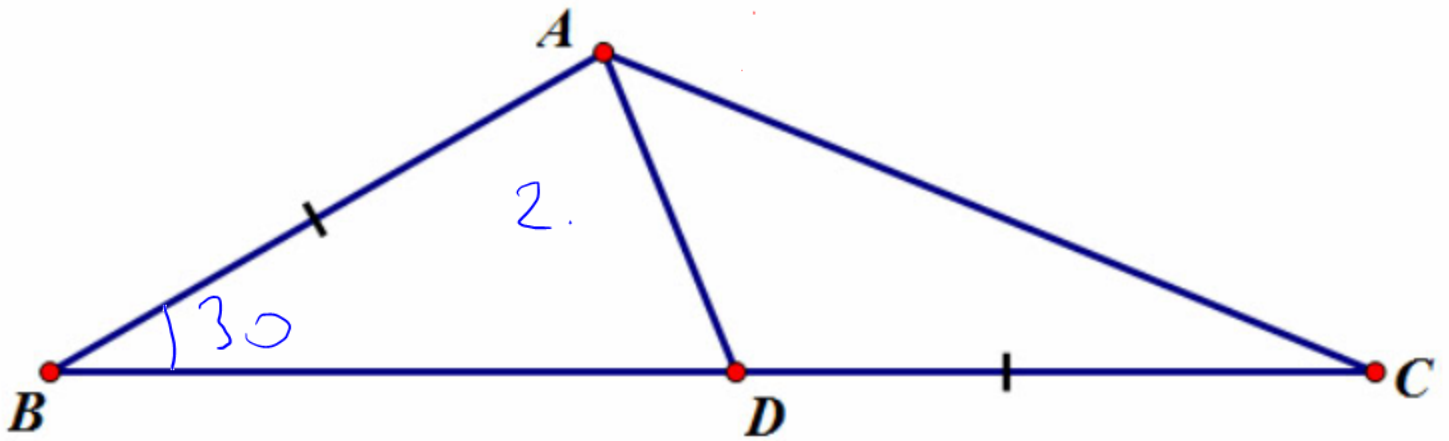
$(127.5, 112.5, 30)$ 

(127.5, 112.5, 30)

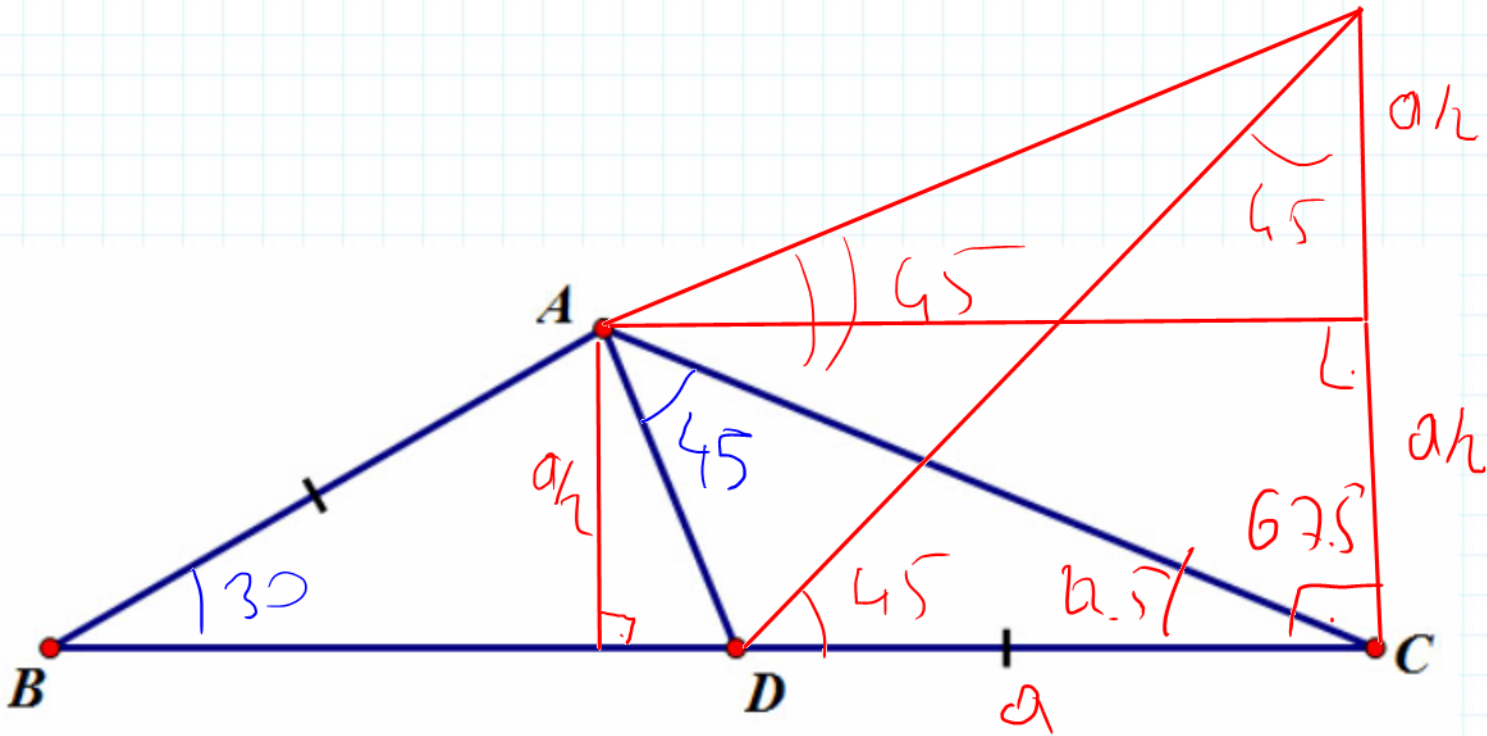

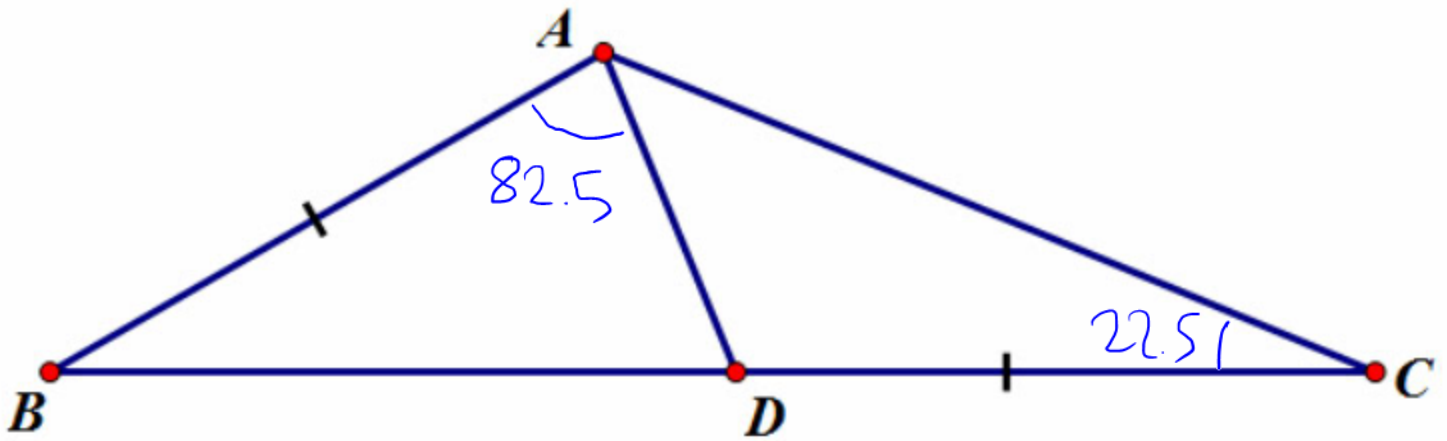
$(127.5, 112.5, 30)$ 

$(127.5, 112.5, 30)$

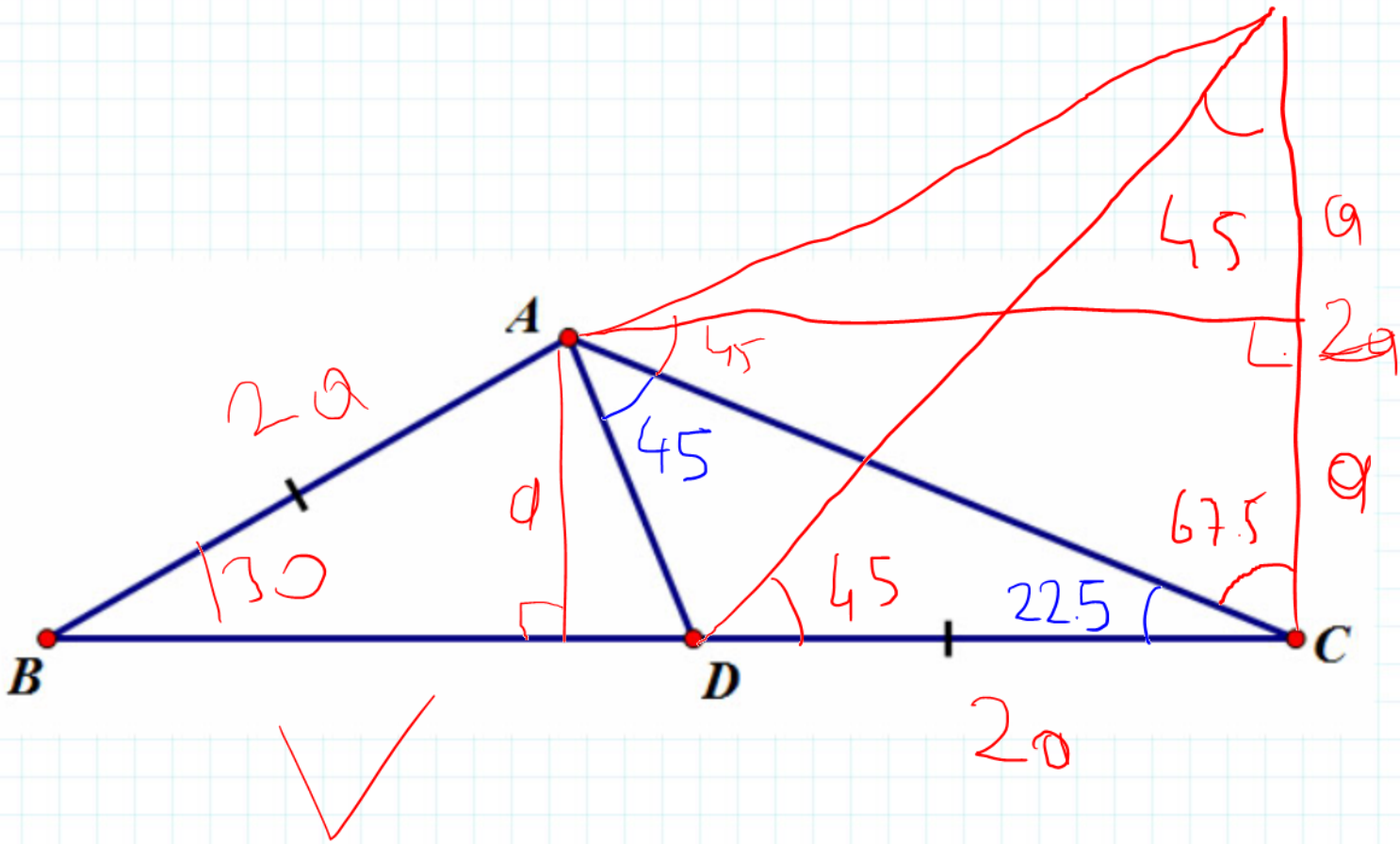

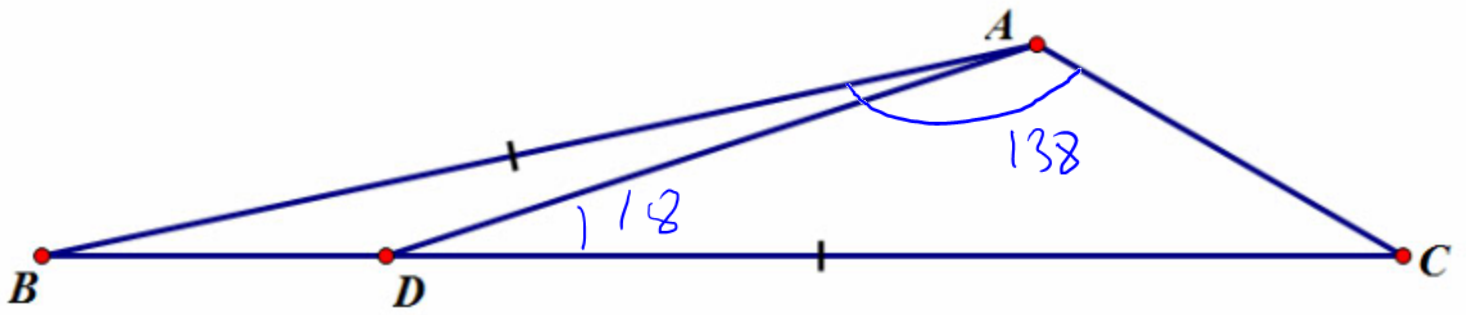
$(138, 18, 12)$ 

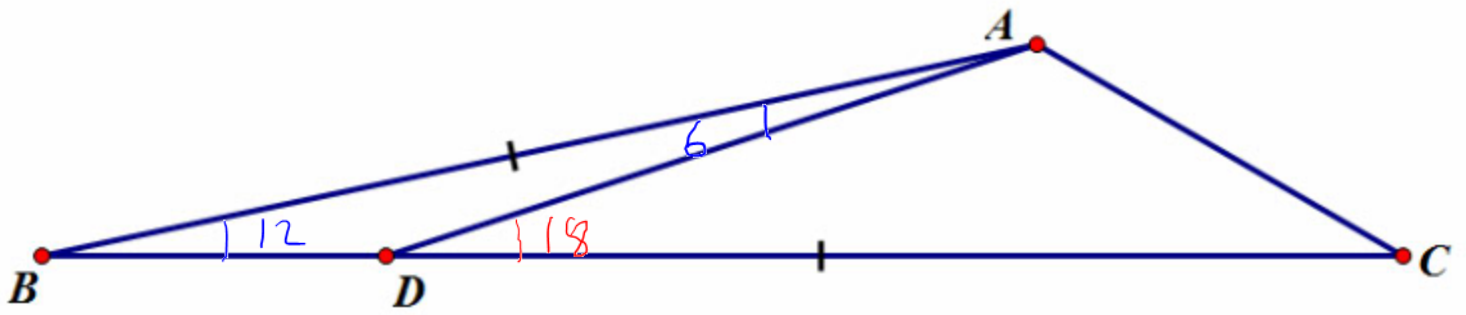
$(138, 18, 12)$ 

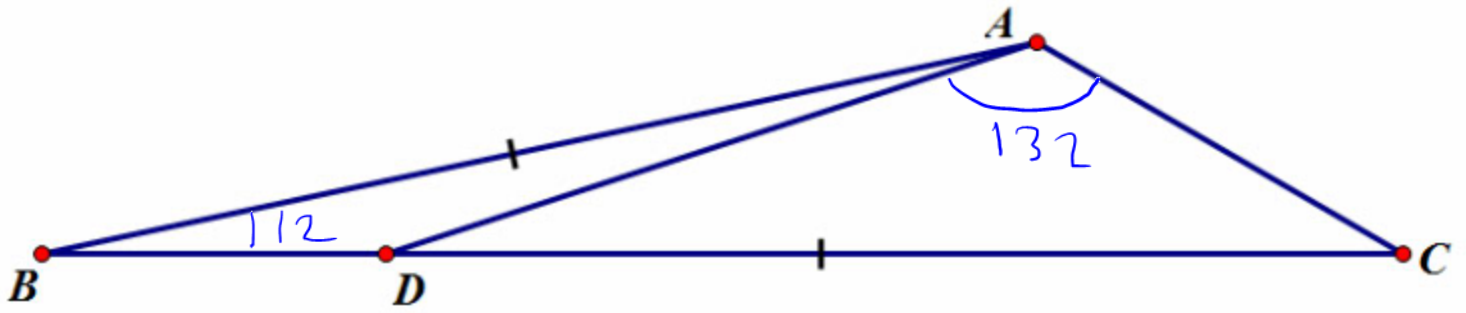
$(138, 18, 12)$ 

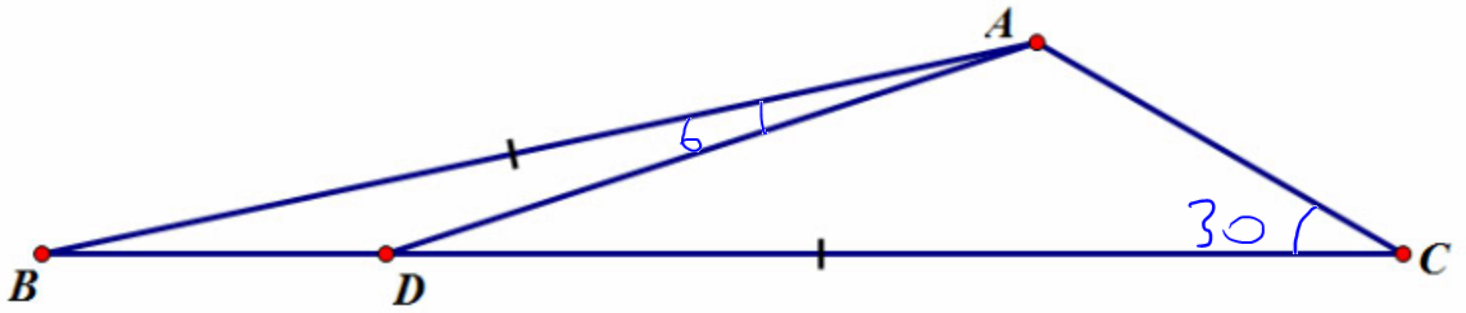
$(138, 18, 12)$ 

$(138, 18, 12)$ 